



*Flavor Burst[®] Soft Serve System
Blended Junior
Operator's Manual
Manual No. 513848*

**Flavor Burst® Stoelting® Ready
4-Flavor Junior Soft Serve
“Blend” System**

Model STL-40BLD-JR
Equipment, Maintenance and
Operations Manual



For questions, support, and ordering
parts, contact Stoelting Company's
White Glove Service.

Phone: 1-800-319-9549

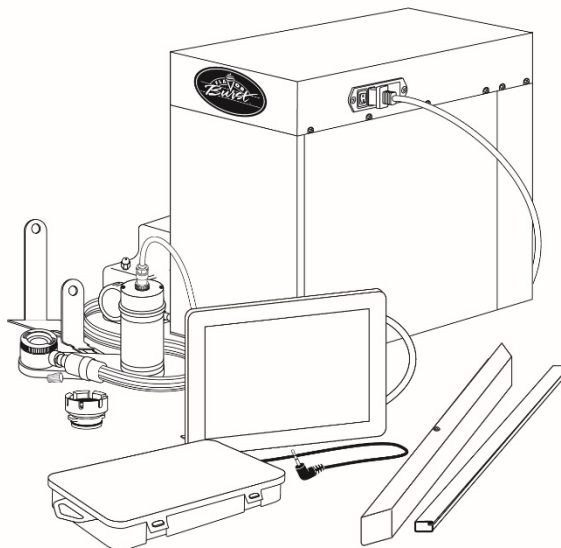

Warranty & Installation Form

An installation form is provided with every STL-40BLD-JR system, located inside the unit with this manual. It is important that the operator / installer completely fill out the installation documents accompanying the unit before using this system. Any questions or concerns regarding the warranty should be clarified upon delivery or installation. For warranty details please refer to Stoelting's website www.stoeltingfoodservice.com.

TABLE OF CONTENTS

FCC Conformity Statement	3
Introduction	4
Guidelines For The Best Blend	4
Safety Precautions	4
Environmental Notices	5
Parts Identification/Function	7
Daily Opening Procedures	22
Sanitizing the Blending System.....	22
Assembling the Blending Assembly.....	23
Installing the Blending System.....	24
Other items to check during opening procedures.....	25
Daily Closing Procedures	26
Removing the Blending System.....	26
Disassembling the Blending Assembly.....	27
Sanitizing the Blending System.....	28
Replacing the Syrup Flavors	30
Scheduled Maintenance	34
Clean-In-Place (CIP) Procedure.....	34
<i>CIP – Phase 1: Prep</i>	34
<i>CIP – Phase 2: Flush</i>	36
<i>CIP – Phase 3: Clean</i>	37
<i>CIP – Phase 4: Reassemble</i>	38
Refilling the Sanitizer Tank.....	39
Priming the Syrup System.....	40
Replacing Blending Head O-Rings.....	40
Miscellaneous Cleaning Procedures.....	41
<i>Cleaning the Blending Assembly Suspension Bracket</i>	42
<i>Area Under the Cabinet</i>	43
<i>Inside the Cabinet</i>	43
<i>Tube / Cable Casing Assemblies</i>	43
<i>9-Tube Assembly Syrup Lines</i>	44
<i>Touch Panel and Mounting Bracket</i>	44
Winterizing the Unit	45

TABLE OF CONTENTS (continued)

Equipment Setup	48
Installing the Touch Panel and Mounting Bracket.....	48
Draw Switch Options.....	51
<i>Installing the Draw Switch Extension</i>	51
<i>Installing the Draw Handle Switch</i>	51
Sanitizing the Blending System.....	52
Assembling the Blending Assembly.....	52
Installing the Spout Adapter.....	53
Installing the Blending System and Suspension Bracket.....	53
Mounting the Tube / Cable Casing Assemblies.....	56
Connecting the Unit Syrup Line.....	58
Installing and Filling the Sanitizer Tank.....	58
Power Connections and Power Up.....	59
Installing Flavors and Priming Syrup Lines.....	60
Color Touch Panel Overview	62
Quick Reference Guide for Color Touch Panel Setup.....	62
Testing the STL-40BLD-JR System.....	63
Directory of Cleaning Procedures	66
Parts Replacement Schedule	67
Recommended Maintenance Items Replacement Schedule	68
Alternate Parts and Kits by Freezer Model	68
Ordering/Service Information	69

FCC Conformity Statement:

This device complies with Part 15 of the FCC Rules. Operation is subject to the following two conditions: (1) this device may not cause harmful interference, and (2) this device must accept any interference received, including interference that may cause undesired operation.

Changes or modifications not expressly approved by the party responsible for compliance could void the user's authority to operate the equipment.

NOTE: This equipment has been tested and found to comply with the limits for a Class B digital device, pursuant to Part 15 of the FCC Rules. These limits are designed to provide reasonable protection against harmful interference in a residential installation. This equipment generates, uses and can radiate radio frequency energy and, if not installed and used in accordance with the instructions, may cause harmful interference to radio communications. However, there is no guarantee that interference will not occur in a particular installation. If this equipment does cause harmful interference to radio or television reception, which can be determined by turning the equipment off and on, the user is encouraged to try to correct the interference by one or more of the following measures:

- Reorient or relocate the receiving antenna.
- Increase the separation between the equipment and receiver.
- Connect the equipment into an outlet on a circuit different from that to which the receiver is connected.
- Consult the dealer or an experienced radio/TV technician for help.

FCC RF Radiation Exposure and SAR Statements SAR Statement.

The Flavor 10* has been tested for body-worn Specific Absorption Rate (SAR) compliance. The FCC has established detailed SAR requirements and has established that these requirements. RF Exposure Information. The radio module has been evaluated under FCC Bulletin OET 65C (01-01) and found to be compliant to the requirements as set forth in CFR 47 Sections, 2.1093, and 15.247 (b) (4) addressing RF Exposure from radio frequency devices. This model meets the applicable government requirements for exposure to radio frequency waves. The highest SAR level measured for this device was 0.293W/kg.

**The Flavor 10 is also referred to as the Touch Panel throughout this manual.*

INTRODUCTION

Congratulations on your purchase of the Flavor Burst Stoelting-Ready flavoring system. As a food and beverage provider, your customers are your greatest asset. Your primary concern must be the health and welfare of your customers. This manual provides everyday operating guidelines and procedures. Special functions have been incorporated into the equipment to provide simple and effective cleaning and sanitizing of your unit. We urge you to follow these instructions carefully and maintain strict sanitary practices in your daily operating routine.

The Flavor Burst system is added to a soft serve freezer to inject concentrated flavorings throughout soft serve product as it is dispensed. Dispensing Flavor Burst product is very simple. Select a flavor from the Touch Panel and draw the product. The Flavor Burst system will automatically flavor the product at the spout. You can also have multiple flavors per serving. Simply select the flavors from the Touch Panel and draw the product. The system will switch from one flavor to the next in a smooth, continuous motion, layering the serving with different, delicious flavors. The STL-40BLD-JR model is a 4-flavor system with a short cabinet and compact sanitizer tank.

Flavor Burst® syrup is stored within the equipment cabinet in 1-gallon disposable bags. Proper syrup injection rate is maintained by adjusting the flavor level on the system Touch Panel.

Components of the STL-40BLD-JR system should be cleaned daily to ensure the highest standard of sanitation. When your equipment is delivered or if it has been unused for more than 24 hours, follow the DAILY OPENING PROCEDURES.

NOTE: PARTS AND PART NUMBERS MAY VARY FROM WHAT IS SHOWN AND LISTED. CONTACT STOELTING COMPANY'S WHITE GLOVE SERVICE IF YOU HAVE ANY QUESTIONS. Phone 800-319-9549

GUIDELINES FOR THE BEST BLEND

The Blend system mixes concentrated syrup with base product in a very small area, and in a very short amount of time. For best results in thoroughly and evenly mixing the syrup with the base product, follow these recommended guidelines.

BASE PRODUCT: Use a base product that contains 5% or less buttermilk. Not only does the butterfat make it difficult to blend with the water-based syrups, its thick and rich vanilla flavor can overpower the syrup flavor.

DISPENSE RATE: Set your freezer dispense rate so that it dispenses product at ½ ounce of base product per second. This may be considerably slower than what you are used to, but it will give the Flavor Blend system the time it needs to thoroughly blend the syrup and product. Keep in mind, this is still much faster than blending by hand or mixer!

OTHER ADJUSTMENTS: With the previous two recommendations met, adjust the syrup flow rates and freezer temperature as-needed.

SAFETY PRECAUTIONS

Always follow these safety precautions when operating the Flavor Burst® system:



DO NOT operate the system without reading this operator's manual. Failure to follow this instruction may result in equipment damage, poor system performance, health hazards, or personal injury.



DO NOT operate the system unless it is properly grounded. Failure to follow this instruction may result in electrocution.



DO NOT operate the system with larger fuses than specified on the system data label. Failure to follow this instruction may result in electrocution or damage to the machine. Consult your electrician.



DO NOT put objects or fingers in the door spout. Failure to follow this instruction may result in contaminated product or personal injury from blade contact.



The STL-40BLD-JR cabinet system must be placed on a level surface capable of supporting at least 220 lbs of weight. Failure to comply may result in personal injury or equipment damage.



DO NOT place more than 25 lbs of weight on top of the Flavor Burst cabinet. Failure to comply may result in personal injury or equipment damage.



DO NOT install the unit in an area where a water jet could be used, and do not use a water jet to clean or rinse the system. Failure to follow these instructions may result in serious electrical shock.

HAZARD COMMUNICATION STANDARD (HCS) – The procedure(s) in this manual include the use of chemical products. These chemical products will be highlighted in bold-faced letters followed by the abbreviation (HCS) in the text portion of the procedure. See the Hazard Communication Standard (HCS) manual for the appropriate Material Safety Data Sheet(s) (MSDS).



NOISE LEVEL: Airborne noise emission does not exceed 70 dB(A) when measured at a distance of 1.0 meter from the surface of the machine and at a height of 1.6 meters from the floor.



NOTE: Operations Manual subject to change. Contact White Glove Service for most recent updates concerning the STL-40BLD-JR unit.



NOTE: Access to the service area is restricted to persons having safety / hygiene knowledge and practical experience of the appliance.



NOTE: This appliance can be used by children aged from 8 years and above and persons with reduced physical, sensory, or mental capabilities or lack of experience and knowledge if they have been given supervision or instruction concerning use of the appliance in a safe way and understand the hazards involved.



NOTE: Children shall not play with the appliance.



NOTE: Cleaning and user maintenance shall not be made by children without supervision.



NOTE: Operate unit under normal ambient temperatures between 60 and 80 degrees Fahrenheit. Unit should never be exposed to freezing temperatures.

ENVIRONMENTAL NOTICES



If the crossed out wheeled bin symbol is affixed to this product, it signifies that this product is compliant with the EU Directive for Waste Electric/Electronic Goods (WEEE) as well as other similar legislation in affect after August 13, 2005. Therefore, it must be collected separately after is use is completed, and cannot be disposed of as unsorted municipal waste.

The user is responsible for returning the product to the appropriate collection facility, as specified by your local codes. For additional information regarding applicable local laws, please contact the municipal facility and/or local distributor.

PAGE INTENTIONALLY LEFT BLANK

PARTS IDENTIFICATION/FUNCTIONS

General System Overview (See Figure 1)

ITEM	PART NO.	DESCRIPTION	QTY.	FUNCTION
1	STOEELE906A	TOUCH PANEL ASSEMBLY WITH BRACKET	1	Flavor Burst unit command center.
2	STOEINJ424STL-BLD	FLAVOR BLEND ASSEMBLY	1	Blends syrups into the product.
3	STOEMIS3026S	TOUCH PANEL CABLE CASING	1	Conceals and protects the Touch Panel cable, as well as attaches it to the freezer.
4	STOEMIS3196	STAINLESS TUBE / CABLE CASING ASSEMBLY	1	Attaches the flavor lines and/or cables to the side of the freezer.
5	STOEELE525M	MALE TO MALE 48" SWITCH EXTENSION	1	Connects Touch Panel to the freezer switch.
6	STOECAB113	FLAVOR TRAY	4	Houses syrup bags.
7	N/A	FLAVOR BURST SOFT SERVE JUNIOR CABINET 4-FLAVOR	1	Houses 4 syrup trays and bags.
8	STOESYR944	SYRUP BAG CONNECTOR ASSEMBLY	4	Transports syrup from the bag to the pumps.
9	STOESAN740	SANITIZER TANK ASSEMBLY	1	Houses sanitizer cleaning solution.
10	STOESPR5800STL-BLD	SPARE PARTS KIT - BLEND	1	Houses extra spare parts and wear items.
11	STOEELE434	POWER CABLE	1	Supplies the electronics board with power.

General System Overview

26001

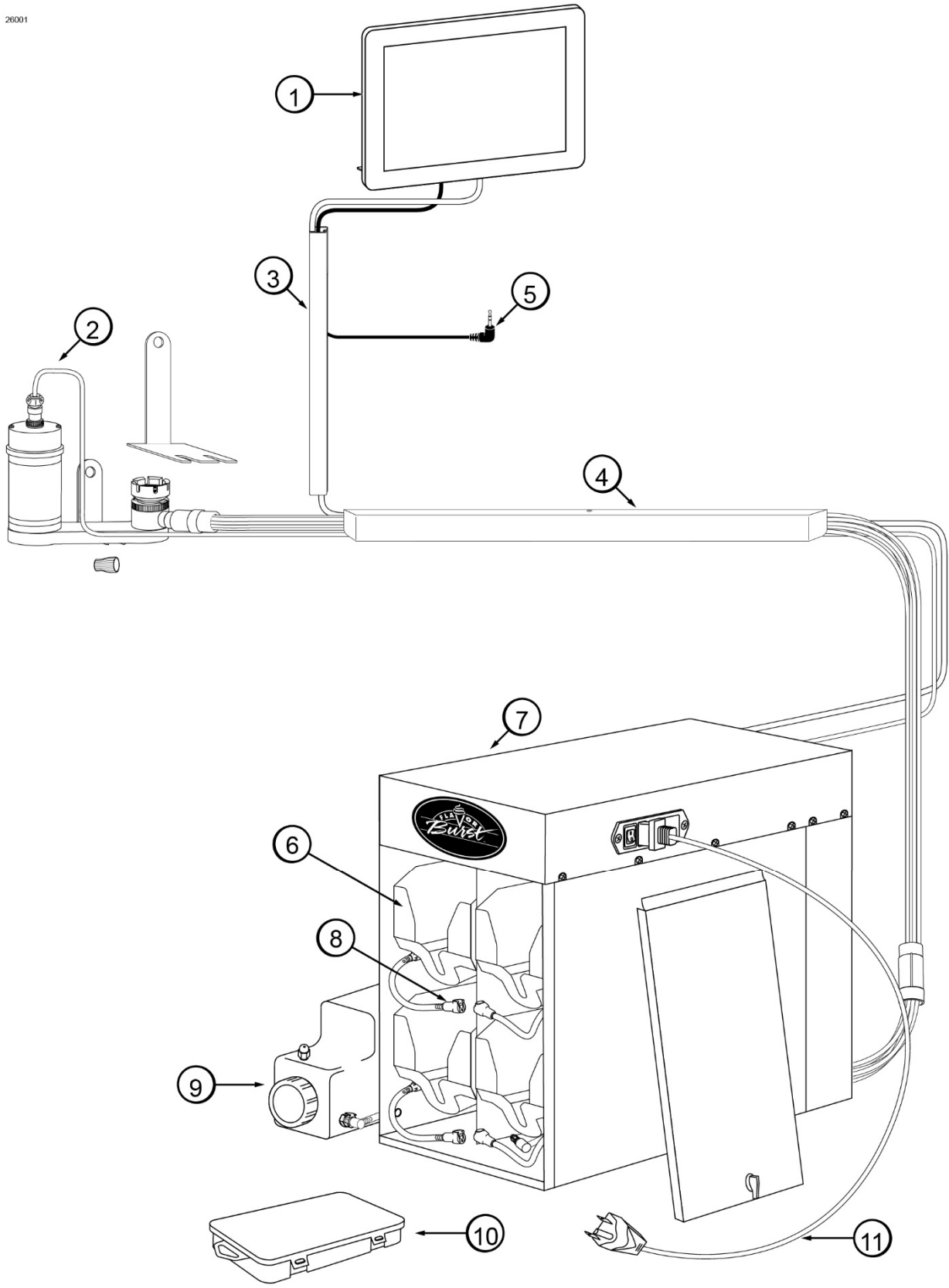

Figure 1

Cabinet – (See Figure 2)

ITEM	PART NO.	DESCRIPTION	QTY.	FUNCTION
1	N/A	ELECTRONICS SYSTEM	1	Control system for the unit.
2	STOECAB135R-4-A	RIGHT SIDE PANEL - JUNIOR	1	Holds tray support brackets and panel brackets.
3	STOECAB145	TRAY SUPPORT BRACKET	4	Supports flavoring trays.
4	STOEFAS2024	8-32 X 1/4 PAN HEAD	22	Fastens panel brackets to divider panel, secures sides.
5	STOEFAS2014	8-32 X 1/2" PAN HEAD	25	Attaches top panel, back cover, and feet to cabinet.
6	STOESYR944	SYRUP TUBE ASSEMBLY – SOFT SERVE	4	Transports the flavoring from the syrup bag to the syrup pump.
7	STOEELE932	PUMP & SANITIZER CABLE HARNESS	1	Provides power to the syrup and sanitizer pumps.
8	STOEMIS3066	MINI BUSHING	2	Protects flush tube.
9	STOEMIS3028-80	FLUSH TUBE ASSEMBLY	1	Connects with flavor line to flush with sanitizer solution.
10	STOECAB139-4	FRONT DOOR PANEL - JUNIOR	1	Provides easy access to syrup bags and connectors.
11	STOECAB136-4-A	REAR PUMP COVER - JUNIOR	1	Back panel to cover pumps.
12	STOEFIX1023	3/16" X 3/16" BARB TUBE CONNECT	1	Splices together flush tubes.
13	STOECAB134-4	DIVIDER PANEL - JUNIOR	1	Holds tray support brackets and divides flavor trays.
14	STOECAB144R	RIGHT PANEL BRACKET	3	Holds tray support rails.
15	STOECAB144L	LEFT PANEL BRACKET	1	Holds tray support rails.
16	STOECAB143	LATCH BRACKET	1	Provides latching tab for front panel latch.
17	STOEFAS2001	FRONT DOOR PANEL LATCH	1	Latches front door to cabinet front.
18	STOESYR927-4	INTERNAL 5-TUBE ASSEMBLY JUNIOR	1	Transports syrup from bags to flavor 9-Tube Assembly.
19	STOESAN748	PERISTALTIC SANITIZER PUMP	1	Pumps sanitizer solution to flush tube and sanitizer line.
20	STOESYR307	PERISTALTIC SYRUP PUMP	4	Pumps syrup from flavor bags into flavor lines.
21	STOECAB155L-4	PUMP MOUNTING STRIP - JUNIOR	1	Support for syrup trays and spacing between panels.
22	STOECAB155R-4	PUMP MOUNTING STRIP - JUNIOR	1	Support for syrup trays and spacing between panels.
23	STOEFAS2037	TAPPED NYLON SPACER	6	Secures screw to center panel, and support for trays.
24	STOEFAS2032	STANDARD NYLON SPACERS	6	Provides extra support for flavor trays.
25	STOEFAS2034	8-32 X 3/4" MACHINE SCREW	6	Attaches bushings to divider panel.
26	STOEMIS3067	OPEN/CLOSED BUSHING	1	Strain relief for internal 9-Tube Assembly.
27	STOEFIX1033	1/4" X 1/4" BLKHD (PUSH-TO-CONNECT)	1	Connects sanitizer tank tube to the unit.
28	STOETUB803	TUBING-PER FOOT	1	Transports sanitizer solution from tank to pump.
29	STOECAB133	BASE PANEL	1	Attaches the bottom of the inner and side panels.
30	STOERUB618	RUBBER BUMPER WITH WASHER	6	Provides spacing between cabinet base and table.
31	STOEFAS2035	8-32 NUT - EXT. LOCK WASHER	6	Attaches to screw and holds rubber bumper in place.
32	STOEMIS3074	SHORTY PLUG #1672	6	Covers screw hole in rubber bumper.

Cabinet (Continued)

ITEM	PART NO.	DESCRIPTION	QTY.	FUNCTION
33	STOEFAS2040	6-32 X 1/4" TAPPING SCREW	12	Secures tray support bracket to side panels.
34	STOECAB135L-4-A	LEFT SIDE PANEL - JUNIOR	1	Holds tray support brackets and panel brackets.

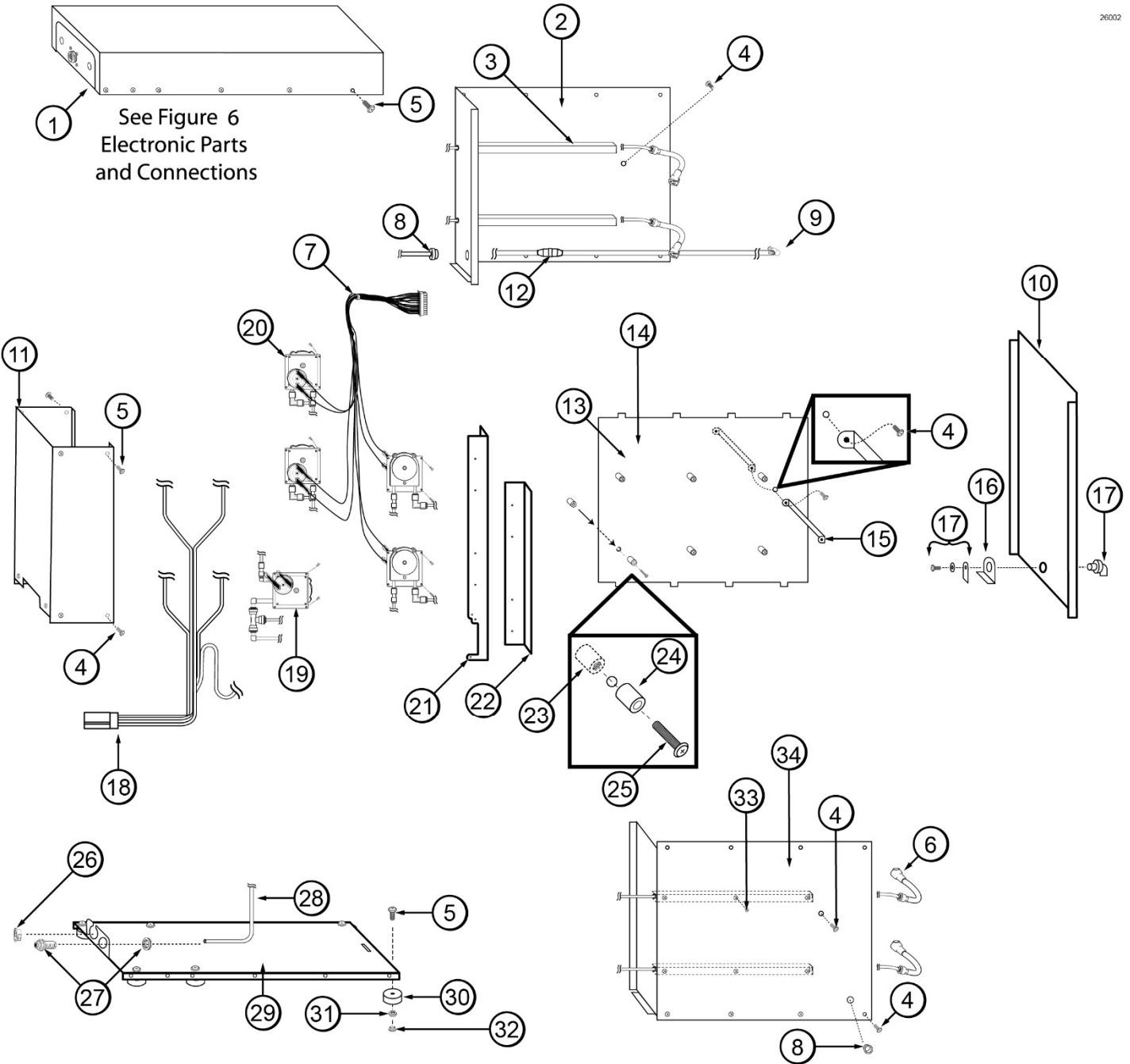

Figure 2

Blending Assembly and Related Parts (See Figure 3)

ITEM	PART NO.	DESCRIPTION	QTY.	FUNCTION
1	STOEINJ424STL-BLD	FLAVOR BLEND ASSEMBLY WITH SYRUP LINES, ADAPTER, & BRACKET	1	Transports and blends syrup into product.
2	STOEINJ422C	BLENDING HEAD ASSEMBLY	1	Connects flavor line to inject syrups into product.
2A	STOERUB652-RSS	SMALLER SYRUP PORT O-RING	1 ea.	Provides sealed cavity inside syrup port.
2B	STOERUB651	BLENDING HEAD O-RING 2-020	1 ea.	Provides a sealed cavity.
2C	STOERUB660	LARGER SYRUP PORT O-RING	1 ea.	Provides sealed cavity inside syrup port.
3	STOEINJ321C	GEAR CARTRIDGE ASSEMBLY	1	Rotates product for even syrup distribution.
4	STOESYR932	6' 9-TUBE ASSEMBLY	1	Supplies syrup to Blending Head from pumps.
4A	STOEFAS2051	ROLLED FLANGE EYELET	18 ea.	Provides tension in syrup line to affix to line coupler.
4B	STOEROT510	LINE COUPLER	2 ea.	Holds flavor lines in place.
4C	STOEROT515C	9-TUBE ASSEMBLY WAVE SPRING	1 ea.	Provides tension between tube connectors.
4D	STOEINJ116	LINE COUPLER NUT - BLACK	1 ea.	Attaches flavor tubes to flavor manifold.
4E	STOESYR901	6' 9-TUBE ASSEMBLY TUBES	9 ea.	Brings syrup from pump to Blending Head.
4F	STOEROT511	LINE COUPLER NUT	1 ea.	Connects flavor lines to the internal 9-Tube Assembly.
4G	STOERUB602	9-POS TUBE CONN. GASKET	1 ea.	Provides sealed cavity.
5	STOEINJ117	TUBE CONNECTOR BODY – BLACK	1	Secures flavor line manifold to flavor lines.
6	STOEMIS3142	FLAVOR LINE DUST CAP – FB 80	1	Covers syrup manifold when not connected.
7	STOEINJ201A	SYRUP MANIFOLD - BLACK	1	Connects flavor line to Blending Head.
8	STOERUB601	9-POS DUCKBILL CHECK VALVE	1	Provides sealed cavity and prevents syrup leakage.
9	STOEMIS3226	BLENDING ASSEMBLY SUSPENSION BRACKET – 4 POST DOOR	1	Supports the Blending Assembly against the freezer door and keeps it level.
10	STOEINJ330HSB	BLENDING MOTOR ASSEMBLY – 7500 RPM	1	Supplies power to Motor which turns gears.
11	STOEINJ331	BLENDING GEARBOX ASSEMBLY	1	Gears turn Gear Cartridge for even syrup distribution.
11A	STOEFAS2023	ACCESSORY MOUNTING BRACKET KNOB	1 ea.	Secures base mounting bracket to Gear Box.
12	STOEAAPT500FBA	SPOUT ADAPTER W/ O-RINGS	1	Attaches Blending Assembly to freezer door.
12A	STOERUB653	SPOUT ADAPTER O-RING	1 ea.	Creates tension to secure adapter to freezer door.
12B	STOEAAPT500FB	SPOUT ADAPTER BODY	1 ea.	Attaches Blending Assembly to freezer.
12C	STOERUB632	SPOUT ADAPTER O-RING	1 ea.	Creates tension to secure adapter to Blending Head.
13	STOEMIS3225	BLENDING ASSEMBLY SUSPENSION BRACKET – 2 POST DOOR	1	Supports the Blending Assembly against the freezer door and keeps it level.

Blending Assembly and Related Parts (Continued)

ITEM	PART NO.	DESCRIPTION	QTY.	FUNCTION
14	STOEMIS3196	STAINLESS 9-TUBE CASING ASSEMBLY	1	Protects and holds the cables and 9-Tube Assembly in place on the freezer side panel.
14A	STOEMIS3190	STAINLESS 9-TUBE CASING HINGED CHANNEL	1 ea.	Covers and protects the cables and tubes of the Casing Assembly.
14B	STOEMIS3051	CH-6 CHANNEL MAGNET ASSEMBLY	2 ea.	Holds the Casing Channel to the freezer panel.
14C	STOEFAS2040	6-32 x 1/4 PAN HEAD SCREW	1 ea.	Secures the Casing cover to the mounting brackets.
14D	STOEFAS2024	8-32 x 1/4 PAN HEAD SCREW	4 ea.	Secures the magnet assembly to the mounting brackets.
14E	STOEFAS2035	8-32 NUT – EXT. LOCK WASHER	4 ea.	Secures the magnet assembly to the mounting brackets.

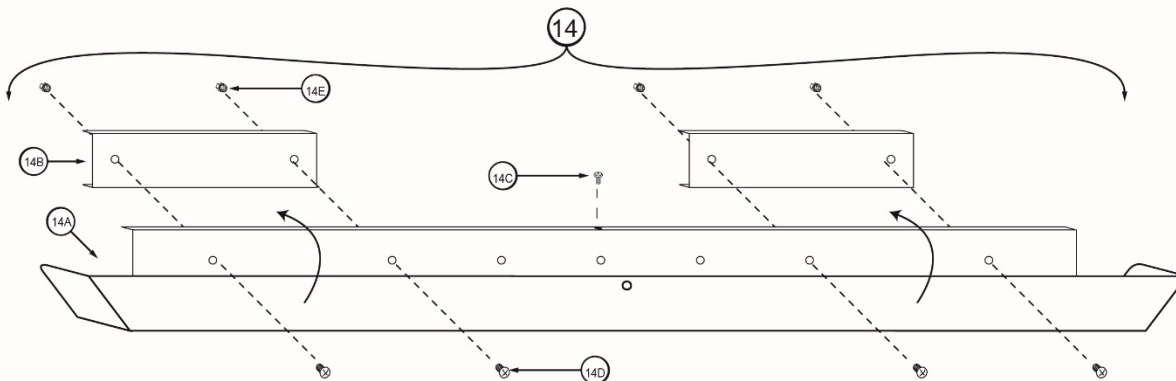
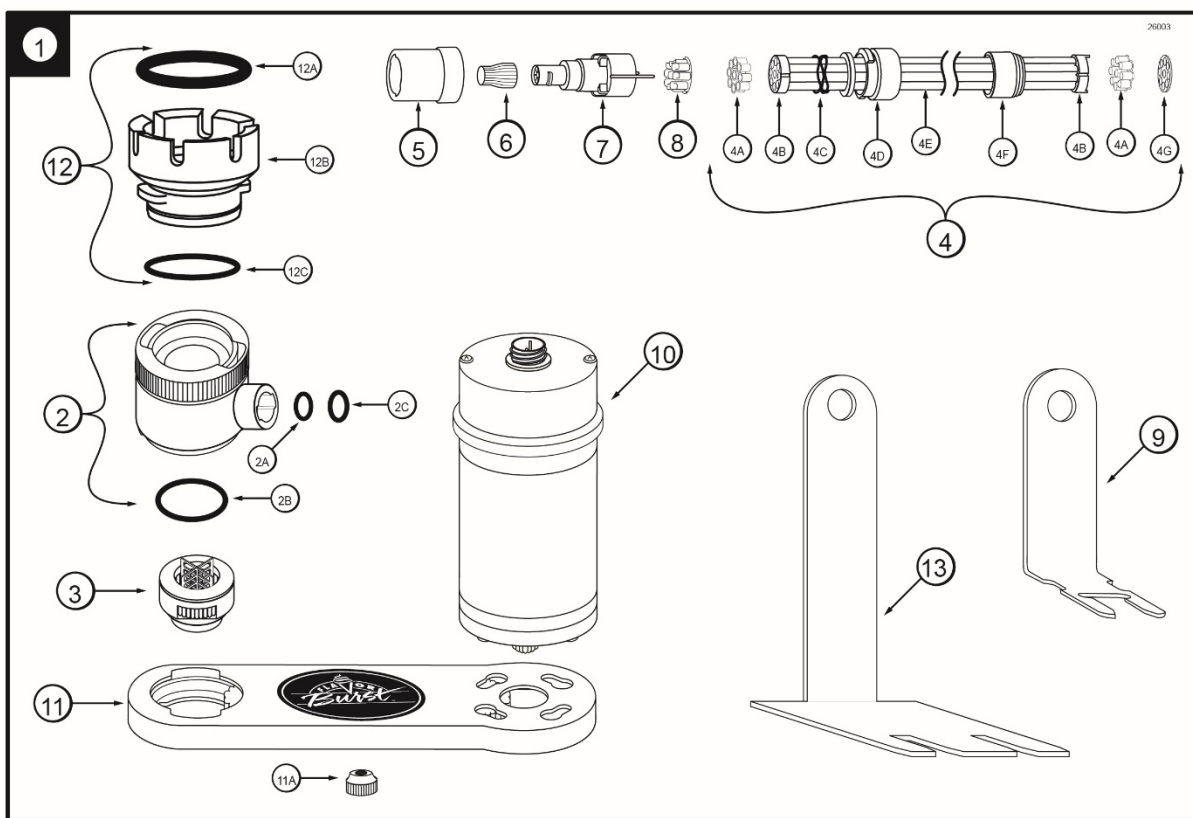

Figure 3

Syrup Pump and Related Parts (See Figure 4)

ITEM	PART NO.	DESCRIPTION	QTY.	FUNCTION
1	N/A	SOFT SERVE SYRUP PUMP	4	Pumps syrup from flavor bags to flavor lines.
1A	STOESYR307	PERISTALTIC SYRUP PUMP	1 ea.	Pumps syrup from flavor bags to flavor lines.
1B	STOETUB806	1/8" SYRUP PUMP REPL TUBE	1 ea.	Transports syrup through pump.
1C	STOEFAS2067	SYRUP PUMP TUBE WASHER-1/4	1 ea.	Secures pump tube.
1D	STOEFAS2066	SYRUP PUMP CLAMP-HOSE-1/4"	1 ea.	Prevents pump tube from slipping.
1E	STOEFAS2051	ROLLED FLANGE EYELET	1 ea.	Creates tension for tighter fit.
1F	STOEFIX1036	1/4" TO 1/4" OD UNION ELBOW	1 ea.	Connects syrup in tube to pump.
1G	STOEFIX1035	1/4 TO 3/16 OD REDUCING UNION	1 ea.	Connects syrup pump to flavor line out.
2	STOESYR944	SYRUP TUBE ASSEMBLY – SOFT SERVE	4	Transports flavor from bag to pump.
2A	STOEFIX1054	1/4" ID HOSE BARB SHUTOFF	1 ea.	Connects flavor line to flavor bag.
2B	STOESYR902	FLAVOR-IN TUBE	1 ea.	Carries syrup from syrup bag to pump.
2C	STOETUB811	TUBE-SILICONE .188X.375 PE FB80	1 ea.	Connects barb fitment to tube port.
2D	STOEFIX1048	FITTING-1/4X1/4 BARB FB80	1 ea.	Connects syrup tube to silicone tube.
3	STOESYR927-4	INTERNAL 5-TUBE ASSEMBLY JUNIOR	1	Transports syrup from bags to flavor 9-Tube Assembly.
3A	STOESYR900	4' 9-TUBE ASSEMBLY TUBE	5 ea.	Brings syrup from pump to Blending Head.
3B	STOEROT511	LINE COUPLER NUT	1 ea.	Connects flavor lines to the internal 9-Tube Assembly.
3C	STOEROT512	TUBE CONNECTOR BODY	1 ea.	Connects internal 9-Tube Assembly to flavor lines.
3D	STOEROT510	LINE COUPLER	1 ea.	Holds flavor lines in place.
3E	STOEFAS2051	ROLLED FLANGE EYELET	5 ea.	Secures flavor lines to line coupler.
3F	STOEMIS3023	FLAVOR LINE DUST CAP	1 ea.	Cover to protect end of flavor lines.
4	STOECAB113	FLAVORING TRAY	4	Houses syrup bags.
5	STOEELE932	PUMP & SANITIZER CABLE HARNESS	1	Provides power to the syrup and sanitizer pumps.

Syrup Pump and Related Parts

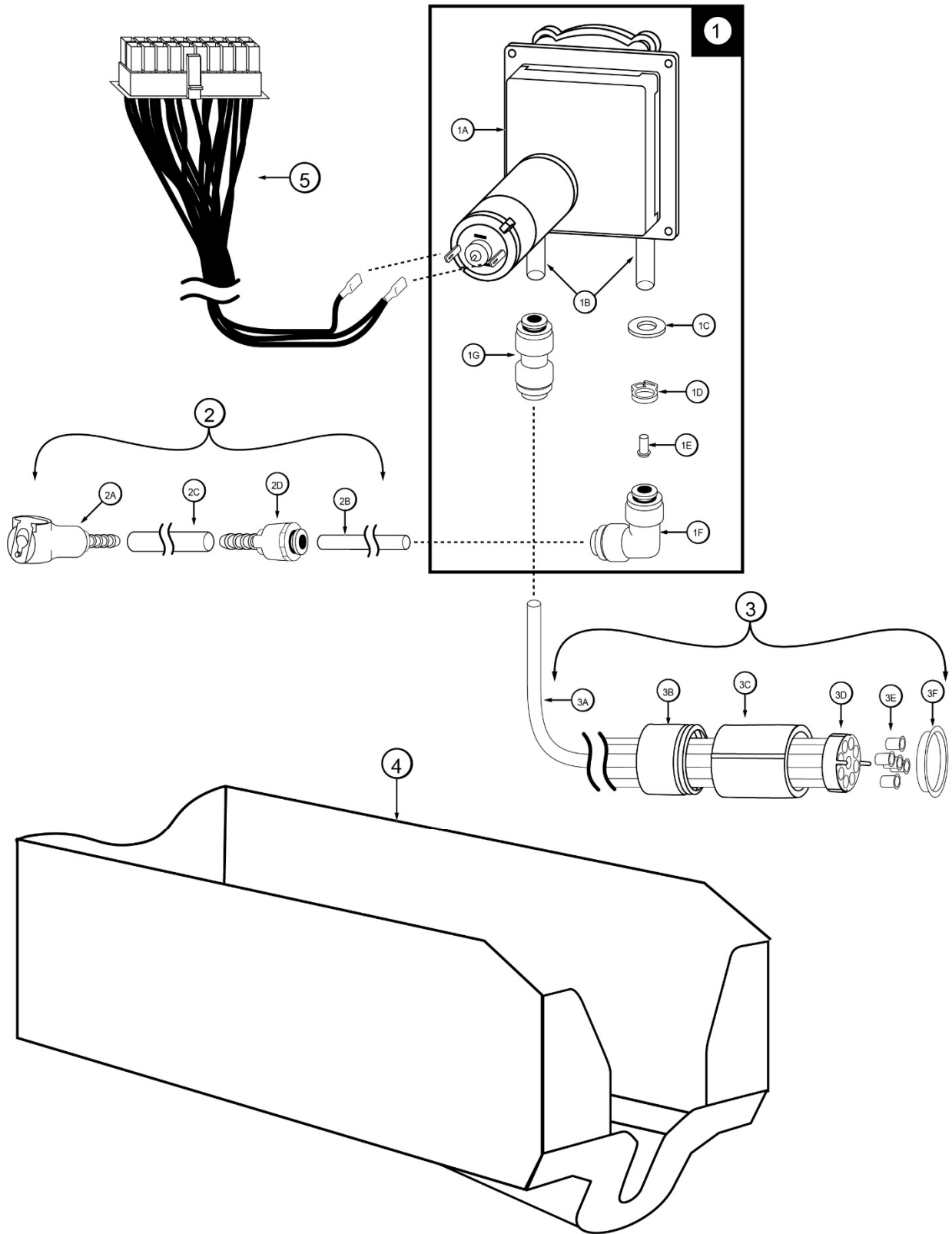

Figure 4

Sanitizer Pump and Related Parts (See Figure 5)

ITEM	PART NO.	DESCRIPTION	QTY.	FUNCTION
1	STOEMIS3028-80	FLUSH TUBE ASSEMBLY	1	Connects with flavor line to flush with sanitizer solution.
1A	STOESYR931	CLEAR TUBING	1 ea.	Transports sanitizer to Pump Flush Adapter fitment.
1B	STOEFIX1051	1/4" ID HOSE BARB ELBOW	1 ea.	Connects to the syrup line to flush sanitizer solution through it.
2	STOETUB807	SANITIZER TUBE REPLACEMENT	1	Transports sanitizer through pump.
3	STOESAN748	SANITIZER PUMP ASSEMBLY	1	Supplies sanitizer to flush tube.
4	STOEELE932	PUMP & SANITIZER CABLE HARNESS	1	Provides power to the syrup and sanitizer pumps.
5	STOEFIX1035	1/4 TO 3/16 OD REDUCING UNION	1	Connects elbow to sanitizer line.
6	STOEFIX1042	TUBE-TO-TUBE ELBOW	3	Connects pump tube to reducing union.
7	STOEFIX1053	SANITIZER PUMP T CONNECTOR	1	Connects sanitizer line to flush adapter and pump lines.
8	STOEFIX1023	3/16" X 3/16" BARB TUBE CONNECT	1	Splices together flush tubes.
9	STOESYR931	CLEAR TUBING	1	Transports sanitizer to Pump Flush Adapter.
10	STOETUB803	.17 x 1/4 LDPE TUBING-PER FOOT	1	Transports sanitizer solution from tank to sanitizer pump.
11	STOEFIX1033	1/4" X 1/4" BLKHD (PUSH-TO-CONNECT)	1	Connects sanitizer tank tube to the unit.
12	N/A	SANITIZER TANK TUBE ASSEMBLY	1	Transports sanitizer from the tank to the pump.
12A	STOEFIX1042	TUBE-TO-TUBE ELBOW	1 ea.	Connects the sanitizer tank tube to the back of the cabinet.
12B	STOESYR931	CLEAR TUBING	1 ea.	Transports sanitizer from the tank to the pump.
12C	STOEFIX1051	SANITIZER TANK FITMENT	1 ea.	Connects sanitizer tube to Sanitizer Tank.
13	STOESAN756	SANITIZER TANK ASSEMBLY	1	Houses sanitizer cleaning solution.
13A	STOESAN749	THREADED CHECK VALVE	1 ea.	Allows air to fill Sanitizer Tank.
13B	STOESAN750	SANITIZER TANK DOME NUT	1 ea.	Mounts check valve to Sanitizer Tank.
13C	STOEFIX1052	SANITIZER TANK QUICK CONNECT	1 ea.	Connects sanitizer lines to Sanitizer Tank.
13D	STOESAN755	SANITIZER TANK CAP	1 ea.	Allows Sanitizer Tank to be refilled.
13E	STOESAN754	SANITIZER CAP O-RING	1 ea.	Seals the Sanitizer Tank opening to prevent leakage.
13F	STOESYR931	CLEAR TUBING	1 ea.	Transports sanitizer to flush tubes.
13G	STOESAN752	SANITIZER TANK	1 ea.	Houses sanitizer cleaning solution.
13H	STOERUB604	SANITIZER TANK O-RING	4 ea.	Seals sanitizer tank's quick connect & check valve openings.
14	STOESYR927-4	INTERNAL 5-TUBE ASSEMBLY JUNIOR	1	Transports syrup from bags to 9-Tube Assembly.
14A	STOESYR900	4' 9-TUBE ASSEMBLY TUBE	5	Brings syrup from pump to Blending Head.
14B	STOEROT511	LINE COUPLER NUT	1	Connects flavor lines to internal Tube Assembly.
14C	STOEROT512	TUBE CONNECTOR BODY	1	Connects internal 9-Tube Assembly to flavor lines.
14D	STOEROT510	LINE COUPLER	1	Holds flavor lines in place.
14E	STOEFAS2051	ROLLED FLANGE EYELET	5	Secures flavor lines to line coupler.
14F	STOEMIS3023	FLAVOR LINE DUST CAP	1	Cover to protect end of flavor lines.

Sanitizer Pump and Related Parts

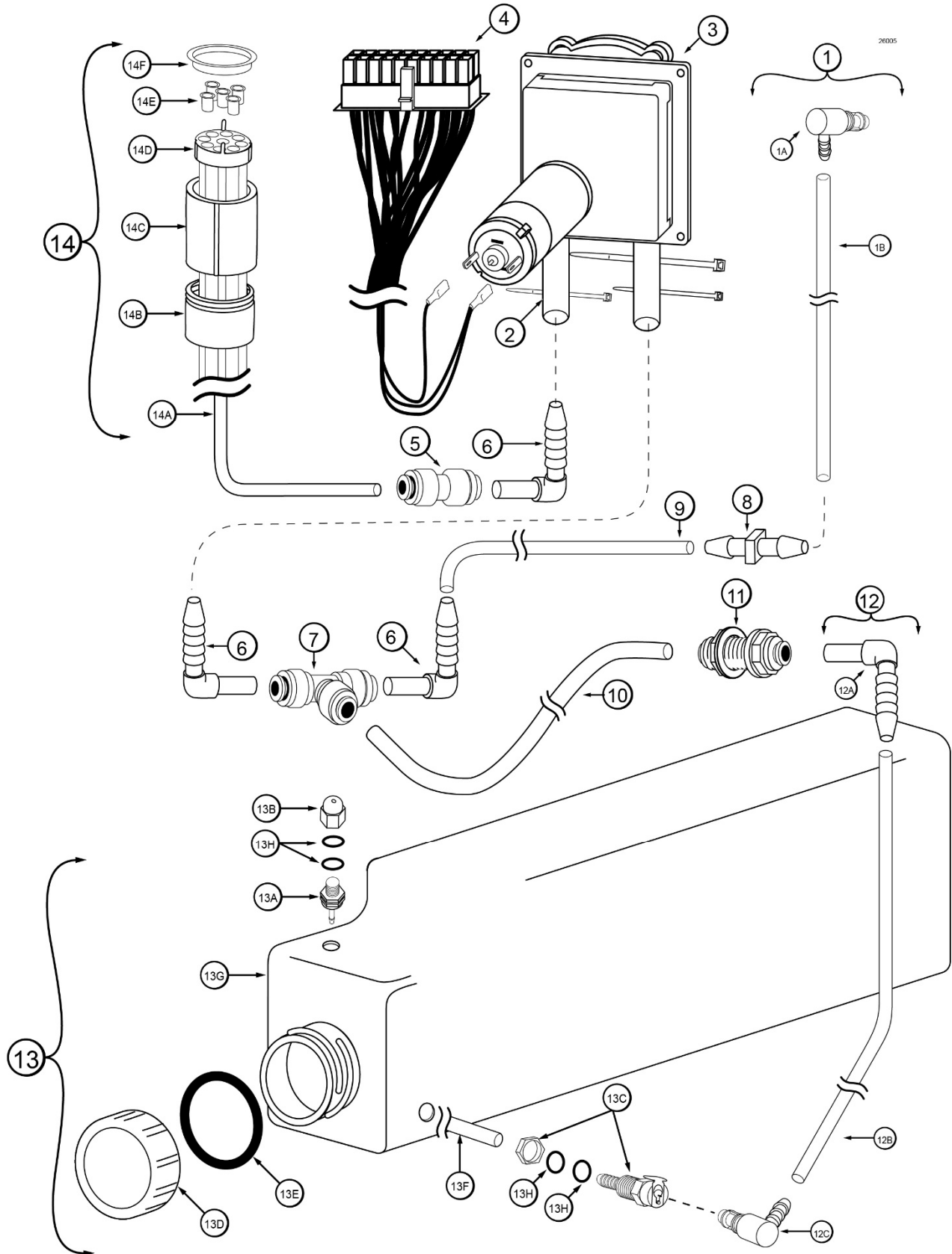

Figure 5

Electronic Parts and Connections (See Figure 6)

ITEM	PART NO.	DESCRIPTION	QTY.	FUNCTION
1	STOEELE906	FLAVOR 10 COLOR TOUCH PANEL	1	Control system for the unit.
2	STOEMIS3214	TOUCH PANEL MOUNTING BRACKET ASSEMBLY	1	Secures the Touch Panel to the freezer.
2A	STOEMIS3214A	TOUCH PANEL MOUNTING PLATE	1 ea.	Attaches the Touch Panel to the anchor bracket.
2B	STOEMIS3214B	MOUNTING ANCHOR BRACKET	1 ea.	Allows the bracket to be angled up or down.
2C	STOEMIS3214C	MOUNTING BASE PLATE	1 ea.	Creates a mounting base for the bracket assembly.
2D	STOEFAS2170	M4 X 8 PHILLIPS SCREW	4 ea.	Secures the mounting plate to the Touch Panel.
2E	STOEFAS2174	1/4 - 20 NYLON LOCK NUT S.S.	2 ea.	Secures the anchor bracket in a fixed position.
2F	STOEMIS3076	ADHESIVE PAD	1 ea.	Secures the mounting bracket to the freezer.
2G	STOEFAS2172	1/4-20 X 1/2 HEX BOLT	2 ea.	Hinges Touch Panel plate and anchor bracket.
2H	STOEFAS2023	MOUNTING BRACKET KNOB	4 ea.	Secures anchor bracket to the base plate.
2I	STOEFAS2171	M4 LOCK WASHER	4 ea.	Secures connection between screw and plate.
2J	STOEFAS2173	FLAT WASHER 18-8 S.S.	2 ea.	Secures connection between bolt and nut.
3	STOEELE931	EXTERNAL ROTOR CABLE	1	Connects the external rotor cable to the electronics board.
4	STOEINJ330HSB	BLENDING MOTOR ASSEMBLY – 7500 RPM	1	Supplies power to Motor to turns gears.
5	STOEELE525M	MALE TO MALE 48" SWITCH EXTENSION	1	Connects Touch Panel to the freezer switch.
6	STOECAB137-B	ELECTRONICS COVER	1	Protects and covers electronics microprocessor.
7	STOEFAS2014	8-32 X 1/2" PAN HEAD	10	Secures various parts within the top of unit.
8	STOEMIS3150	FLAVOR BURST LOGO DECAL	1	Displays Flavor Burst trademark logo.
9	STOEMIS3026S	TOUCH PANEL CABLE CASING	1	Conceals and protects the Touch Panel cable, as well as attaches it to the freezer.
10	STOEELE485CTP	120V POWER ENTRANCE MODULE	1	Provides a power connection to the outside of the cabinet.
10A	N/A	GROUNDING WIRE	1 ea.	Grounds electricity.
11	STOEELE932	PUMP & SANITIZER CABLE HARNESS – CTP DLX	1	Provides power to the syrup and sanitizer pumps.
12	STOEELE933	POWER SUPPLY JUMPER CABLE	1	Connects the power supply to the electronics board.
13	STOEELE911	ELECTRONICS BOARD	1	Provides power to the system.
14	STOEFAS2024	8-32 X 1/4 PAN HEAD SCREW	4	Secures electronics board to the base panel.
15	STOEFAS2035	8-32 NUT - EXT. LOCK WASHER	5	Secures electronics board to base panel and grounding wire to the cap.
16	STOEMIS3004	CTP ETHERNET CABLE PLATE	1	Converts the touchscreen cable hole to an ethernet cable hole.
17	STOEELE930	INTERNAL ROTOR CABLE	1	Connects the external rotor cable to the electronics board.
18	STOEFAS2008	4-40 X 3/8" PAN HEAD SCREW	4	Attaches the ethernet plate to the panel.
19	STOEMIS3166	CLOSURE PLUG 3/4 INCH	1	Closes up extra opening in the base panel.
20	STOEELE434	POWER CABLE	1	Supplies the electronics board with power.
21	STOEELE927	RJ45 ETHERNET CABLE GLAND	1	Secures the Ethernet cable to the cabinet.
22	STOEELE925	RJ45 ETHERNET CABLE - EXTERNAL	1	Connects the Touch Panel to the cabinet.

Electronic Parts and Connections (Continued)

ITEM	PART NO.	DESCRIPTION	QTY.	FUNCTION
23	STOEELE926	RJ45 ETHERNET CABLE - INTERNAL	1	Connects the Ethernet cable to the electronics board.
24	STOECAB138TS-B	ELECTRONICS BASE PANEL – LOW PROFILE	1	Secures microprocessor.
25	STOEFAS2042	4/40 LOCK NUT	4	Secures the Ethernet plate and screws.

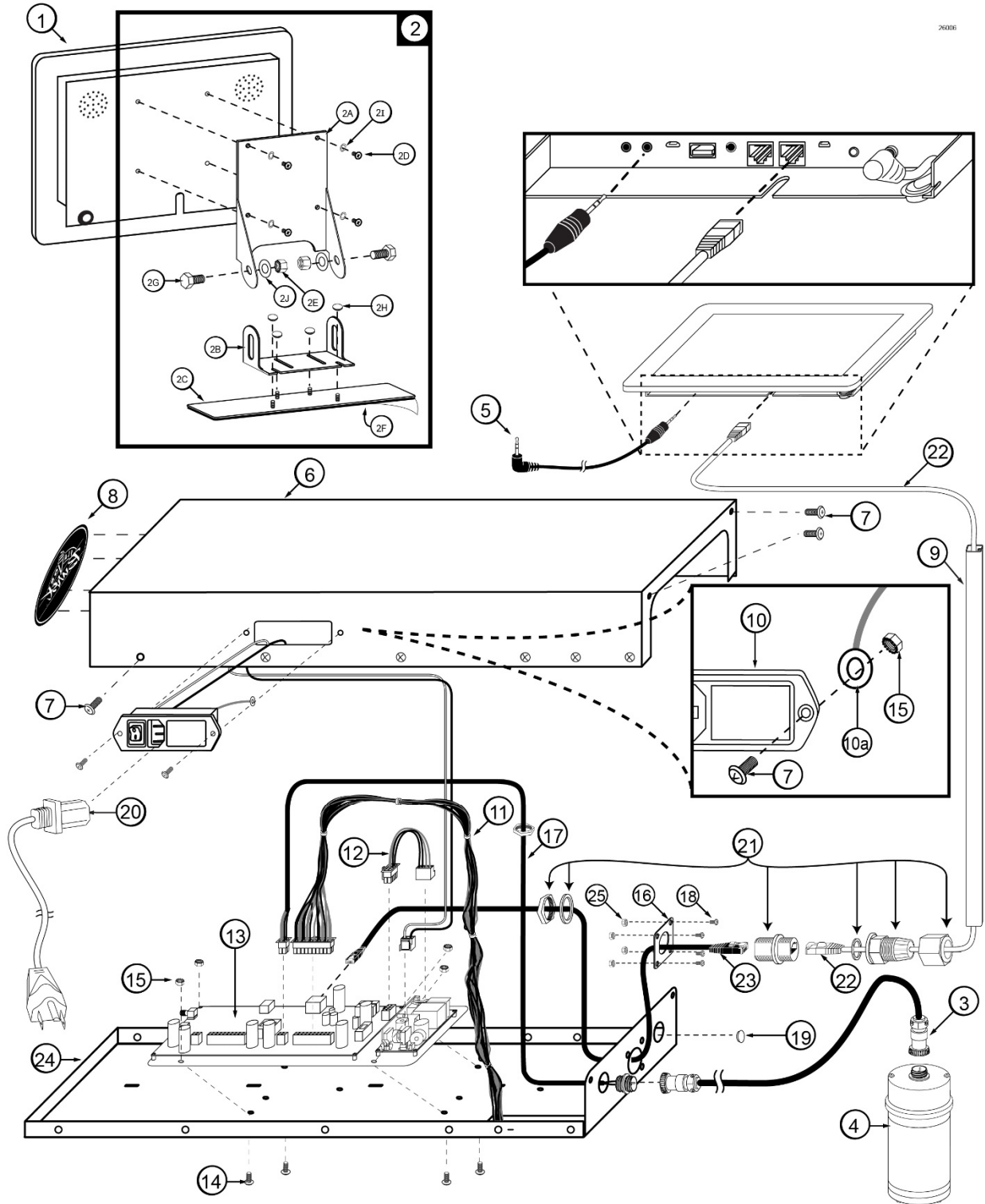

Figure 6

Spare Parts Kit (See Figure 7)

ITEM	PART NO.	DESCRIPTION	QTY.	FUNCTION
1	STOESPR5800STL-BLD	SPARE PARTS KIT – SOFT SERVE BLEND	1	Houses extra spare parts and wear items.
2	STOEINJ321C	GEAR CARTRIDGE	1	Rotates product for even syrup distribution.
3	STOERUB601	9-POS DUCKBILL CHECK VALVE	1	Provides sealed cavity and prevents syrup leakage.
4	STOERUB653	UPPER ADAPTER O-RING FOR STOEADPT500FBA ADAPTER	1	Creates tension to secure adapter to freezer door.
5	STOERUB632	LOWER ADAPTER O-RING	1	Creates tension to secure adapter to Blending Head.
6	STOERUB602	9-POS TUBE CONN. GASKET	1	Provides sealed cavity.
7	STOERUB652-RSS	SMALLER SYRUP PORT O-RING	1	Provides sealed cavity inside syrup port.
8	STOERUB660	LARGER SYRUP PORT O-RING	1	Provides sealed cavity inside syrup port.
9	STOERUB651	BLENDING HEAD O-RING 2-020	1	Provides a sealed cavity.
10	STOEINJ201A	SYRUP MANIFOLD - BLACK	1	Connects flavor line to Blending Head.
11	STOEELE430-RE-2	SPIGOT SWITCH – ROUND HANDLE	1	Activates Blending Assembly.
12	STOEINJ117	TUBE CONNECTOR BODY - BLACK	1	Secures syrup line manifold to flavor lines.
13	STOEELE444	1 AMP, 1 1/4" SLOW BLOW FUSE	2	System overload protection.
14	STOECW137	DRIVE MOTOR GEAR	1	Turns the Gear Box gears, powered by the drive motor.

Spare Parts Kit

26007

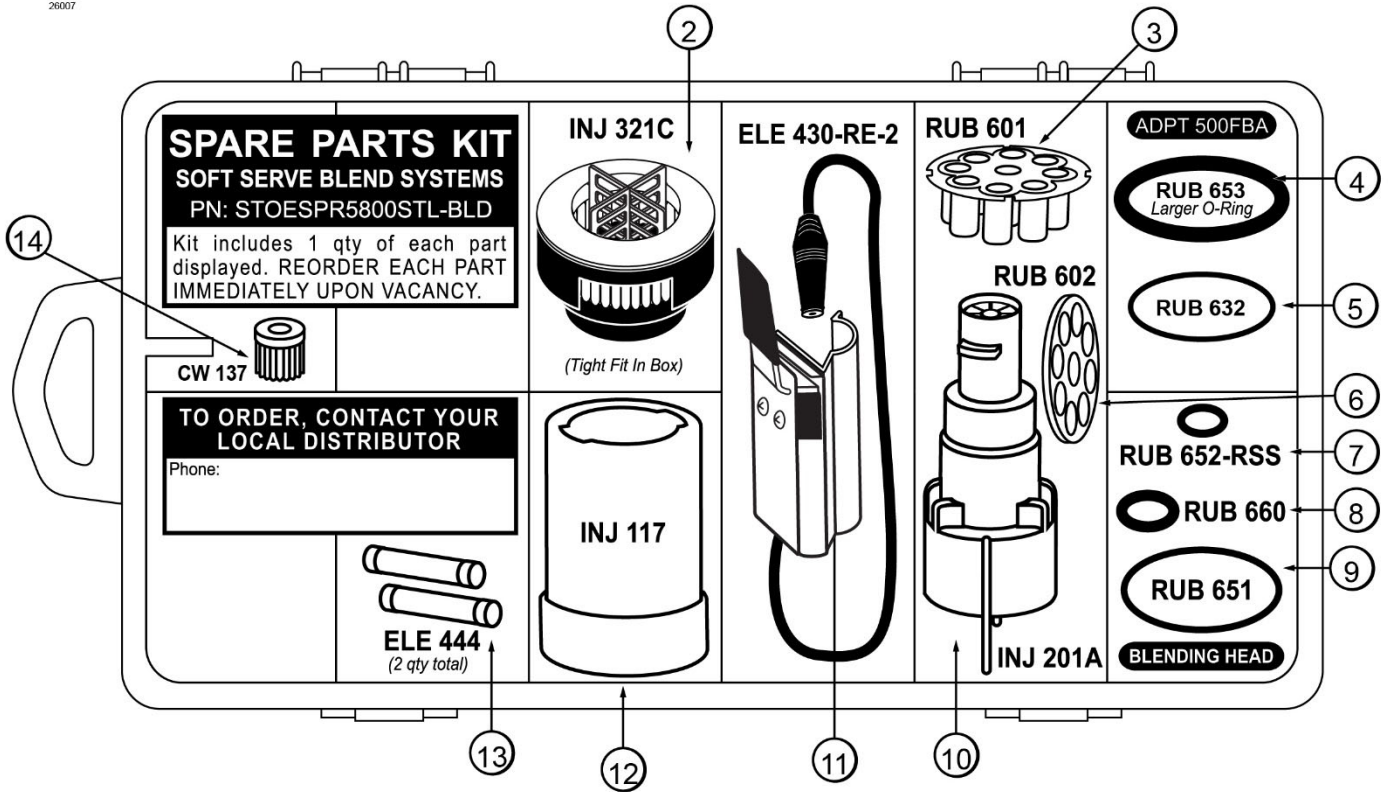

Figure 7

PAGE INTENTIONALLY LEFT BLANK

DAILY OPENING PROCEDURES

NOTE: YOUR HANDS SHOULD BE CLEANED AND SANITIZED BEFORE YOU PERFORM THE FOLLOWING PROCEDURES.

NOTE: THE FOLLOWING PROCEDURES REQUIRE APPROVED, SERVICEABLE AND SANITIZED TOOLS AND BRUSHES. CONTACT WHITE GLOVE SERVICE FOR RECOMMENDED SUPPLIES.

NOTE: USE STERA-SHEEN® GREEN LABEL SANITIZER MIXED WITH WARM WATER (108°F / 42°C) FOR THE FOLLOWING PROCEDURES. REFER TO MANUFACTURER'S INSTRUCTIONS FOR PROPER PREPARATIONS OF THIS CLEANING AGENT.

NOTE: INSPECT ALL WEAR ITEMS AND REPLACE IF NECESSARY.

Ensure that the Blending System has been disassembled and cleaned according to the DAILY CLOSING PROCEDURES. This is typically performed at the close of the previous business day.

Sanitizing the Blending System

1. Prepare a small amount of sanitizer solution by mixing half a packet (1 oz) of Stera-Sheen® Green Label with one gallon of warm water (108°F / 42°C). Pour approximately 16 oz. of this sanitizer solution into a spray bottle.
2. Submerge the Gear Box, nut, spout adapter, o-rings, Gear Cartridge, and Blending Head in the rest of the sanitizer solution and soak for 5 minutes.



3. Remove each part from the sanitizer solution. Place the items on a sanitary tray to air dry.

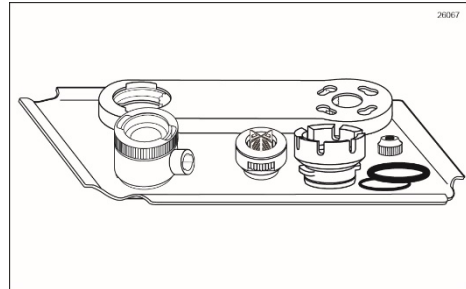

4. Remove the manifold cap and set it on a sanitary tray. Spray the syrup line manifold opening with sanitizer solution and allow it to sanitize for at least 5 minutes.

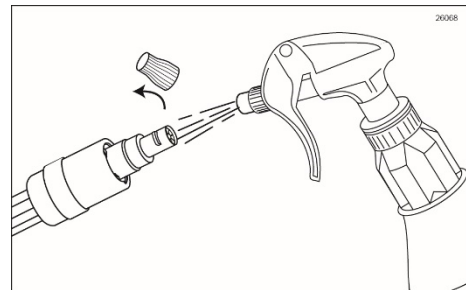

5. Dry the end of the manifold with a clean single service towel.

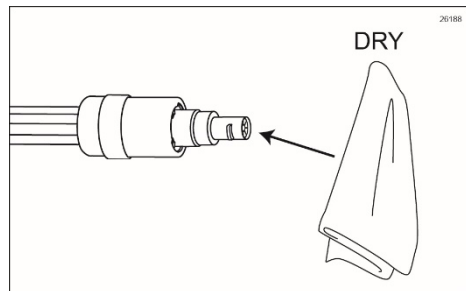

6. The following do not need to be sanitized on a daily basis as part of the daily opening procedures. However, inspect these areas and if necessary, clean according to instructions in the SCHEDULED MAINTENANCE section:

- 9-Tube Assembly Coupler
- 9-Tube Assembly Tubes
- Touch Panel and Mounting Bracket
- Drive Motor
- Exposed surfaces of Cabinet
- Blending Assembly Suspension Bracket

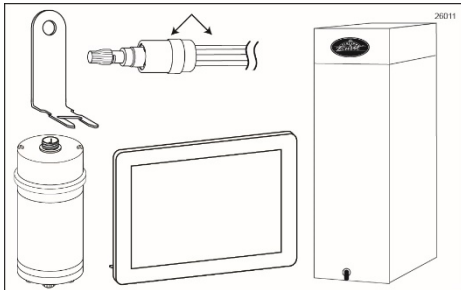

2. Install the Blending Head onto the Gear Box and rotate off-center to secure.

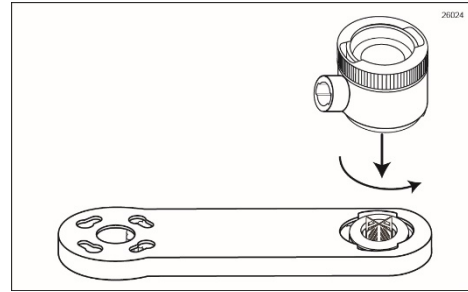

3. Insert the Drive Motor into the Gear Box so that all four locking screws are seated properly and rotate the motor clockwise to secure.

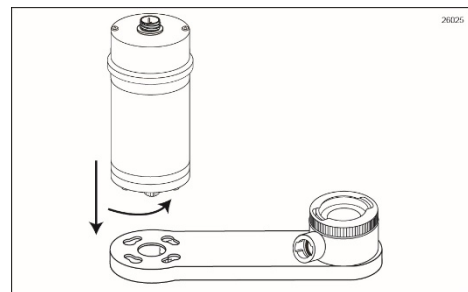

Assembling the Blending Assembly

The Blending Head o-rings, the Gear Cartridge, and the spout adapter o-rings are wear items and will need to be replaced periodically. Check for wear occasionally and always keep spares of these items on hand in the Spare Parts Kit.

1. Place the Gear Cartridge into the Gear Box so that the gear teeth line up with the gear inside the Gear Box.

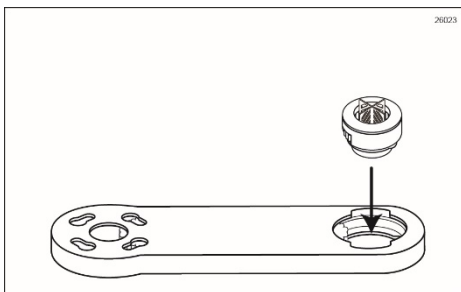

4. Install the o-rings in their proper positions on the adapter body.

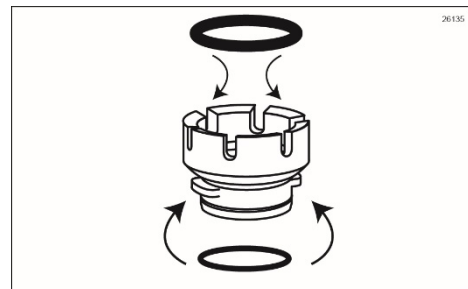

Installing the Blending System

1. Install the spout adapter assembly, complete with o-rings, onto the freezer spout. Push up on the adapter with your palm until it snaps on. Ensure it is evenly and fully installed.

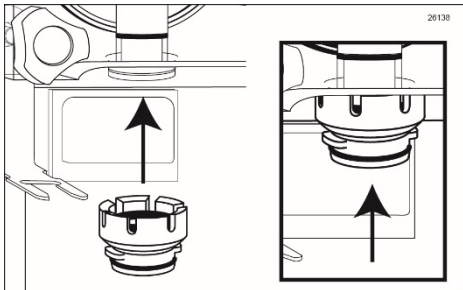

2. Place the Blending Assembly onto the suspension bracket, so that the Gear Box post slides into the bracket opening. Install the Blending Head fully over the spout adapter.

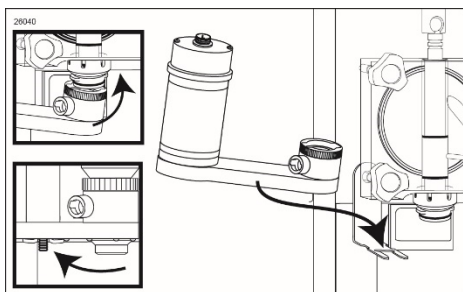

3. Push up on the Blending Assembly and lift the locking collar up and over the adapter tabs. Rotate the locking collar over the tabs to secure.

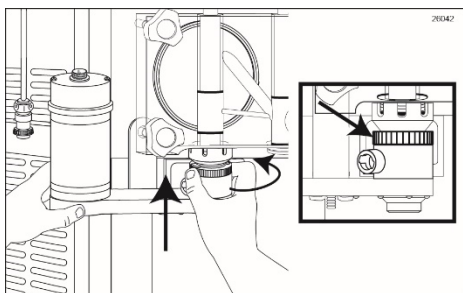

4. Connect the Drive Motor cable to the Motor.

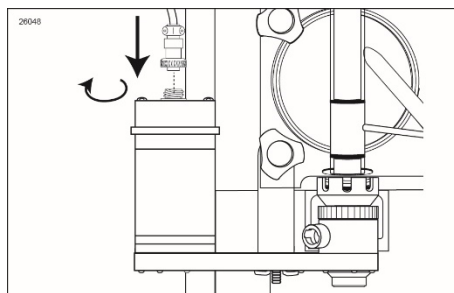

5. Ensure the Blending Assembly is resting level and horizontal. Install and tighten the Gear Box nut to secure the assembly.

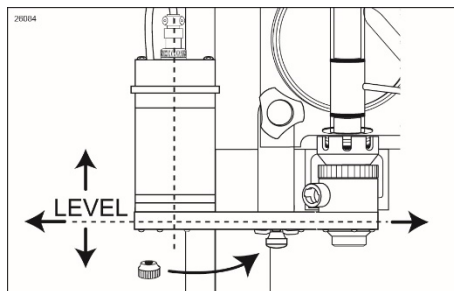

6. Insert the syrup line manifold end fully into the Blending Head syrup line opening. Rotate it until motion stops to secure.

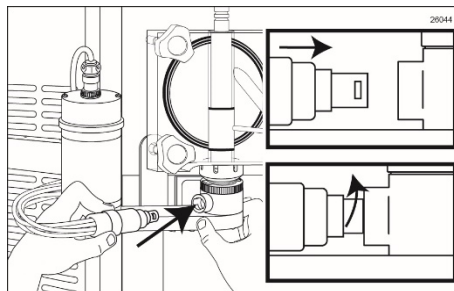

7. With a container under the dispensing spout, press the FLUSH SPOUT key on the Touch Panel to purge any remaining product from the spout.

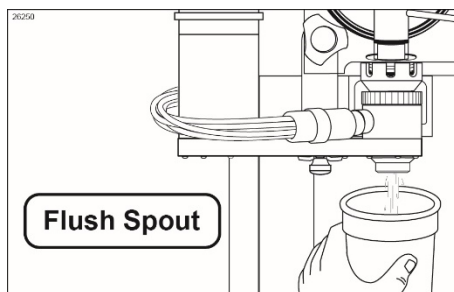

NOTE: IF NO “FLUSH SPOUT” BUTTON IS SHOWN ON THE SCREEN, YOU CAN ACCESS THE KEY UNDER THE “FLUSHING FUNCTIONS” SECTION OF THE MAINTENANCE MENU.

Other items to check during opening procedures

These steps do not necessarily need to be performed as part of the daily opening procedures. The following is a list of areas to check on the Flavor Burst® system during opening procedures. These areas should be checked and adjusted if necessary.

1. Ensure that the sanitizer tank has plenty of approved sanitizer solution that is no older than 28 days. Refill if necessary.
2. Ensure that desired flavors are installed and that none of the flavor bags are empty. Replace flavors according to instructions if necessary.
3. Ensure that the flavor level and the multi-flavored timing are set to a desired level. Make adjustments according to instructions according to the operator's preference.

DAILY CLOSING PROCEDURES

NOTE: YOUR HANDS SHOULD BE CLEANED AND SANITIZED BEFORE YOU PERFORM THE FOLLOWING PROCEDURES.

NOTE: THE FOLLOWING PROCEDURES REQUIRE APPROVED, SERVICEABLE AND SANITIZED TOOLS AND BRUSHES. CONTACT WHITE GLOVE SERVICE FOR RECOMMENDED SUPPLIES.

NOTE: USE STERA-SHEEN® GREEN LABEL SANITIZER AND DAWN® DISH SOAP MIXED WITH WARM WATER (108°F / 42°C) FOR THE FOLLOWING PROCEDURES. REFER TO MANUFACTURER'S INSTRUCTIONS FOR PROPER PREPARATIONS OF THESE CLEANING AGENTS.

NOTE: INSPECT ALL WEAR ITEMS AND REPLACE IF NECESSARY.

Removing the Blending System

Follow these instructions to remove the Blending System from the freezer during closing.

1. With a container under the dispensing spout, press the FLUSH SPOUT button on the Touch Panel to purge any remaining product from the spout.

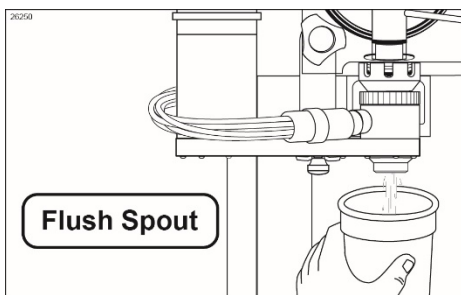

NOTE: IF NO "FLUSH SPOUT" BUTTON IS DISPLAYED ON THE SCREEN, YOU CAN USE THE FLUSH SPOUT BUTTON IN THE "FLUSH FUNCTIONS" SECTION OF THE MAINTENANCE MENU.

2. Rotate the 9-Tube Assembly coupler until it unlocks and is able to slide out of the Blending Head syrup line opening.

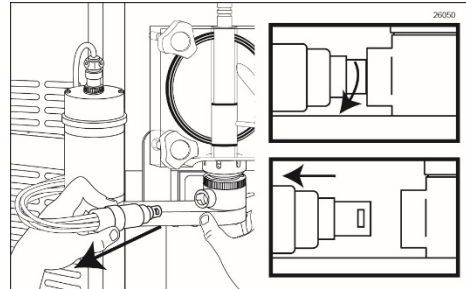

3. Disconnect the Drive Motor cable from the Drive Motor.

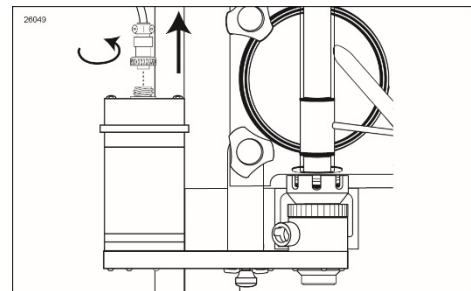

4. Remove the Gear Box nut. Rotate the Blending Head locking collar until it unlocks from the spout adapter and remove the Blending Head from the adapter.

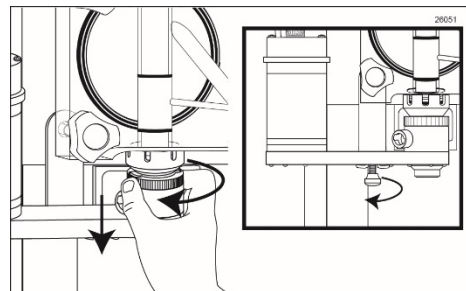

- Remove the Blending Assembly from the Suspension bracket.

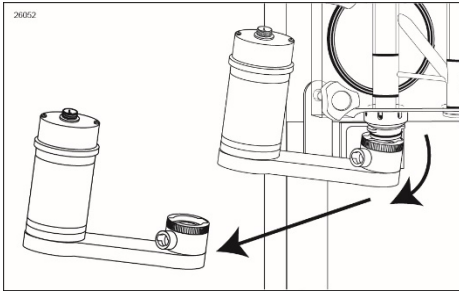

NOTE: DO NOT ATTEMPT TO REMOVE THE SPOUT ADAPTER WITH THE ASSEMBLY ATTACHED! USING THE ASSEMBLY OR GEAR BOX AS LEVERAGE MAY BREAK THE ADAPTER OR SPOUT OR DAMAGE THE BLENDING HEAD.

- Remove the spout adapter from the freezer spout.

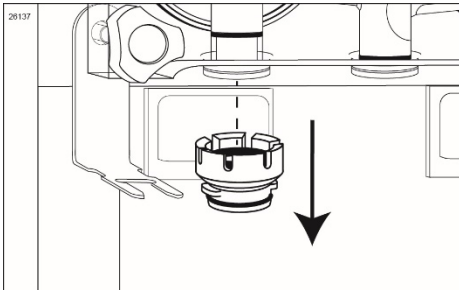

NOTE: YOU MAY USE A CLEAN, NARROW TOOL (SUCH AS A SCREWDRIVER OR OTHER STURDY ROD) TO GENTLY PRY THE ADAPTER OFF. PLACE THE TOOL ON THE ADAPTER PORT AND SLOWLY ANGLE DOWN AGAINST THE FREEZER DOOR.

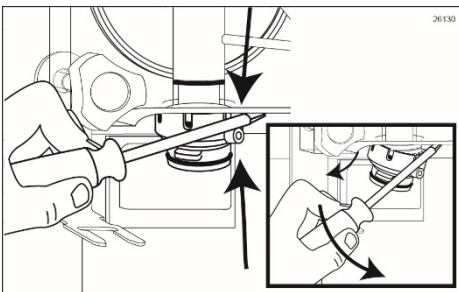

Disassembling the Blending Assembly

- Rotate the Drive Motor to unlock and remove the Motor from the Gear Box.

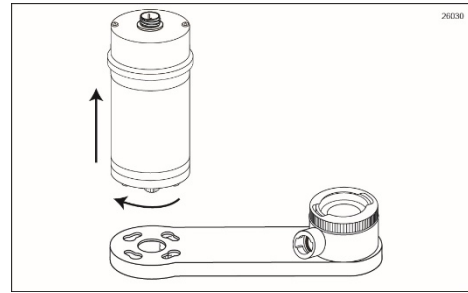

- Rotate the Blending Head to unlock it from the Gear Box.

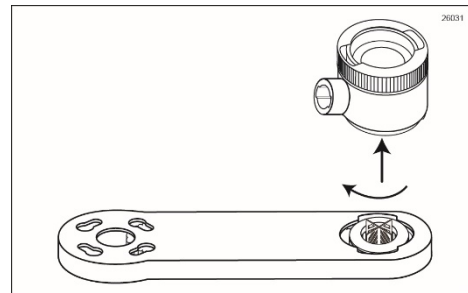

- Remove the Gear Cartridge from the Gear Box.

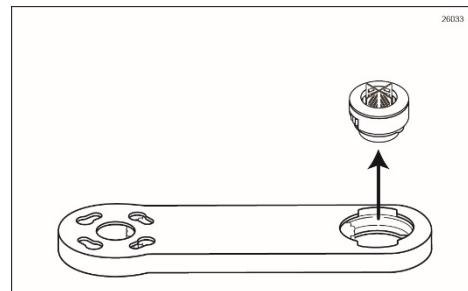

Sanitizing the Blending System

1. Prepare detergent water by mixing several drops of Dawn® dish soap with a gallon of warm water (108°F / 42°C). Prepare sanitizer solution by mixing half a packet (1 oz) of Stera-Sheen® Green Label with one gallon of warm water (108°F / 42°C). Pour approximately 16 oz. of this sanitizer solution into a spray bottle and set aside the rest.
2. Submerge the Gear Box and nut in warm water (108°F / 42°C) and soak for at least 5 minutes. Proceed with Steps 3 and 4 in the meantime.



3. Brush and clean all exposed surfaces of the Gear Cartridge with detergent water, and then rinse thoroughly with warm water (108°F / 42°C).

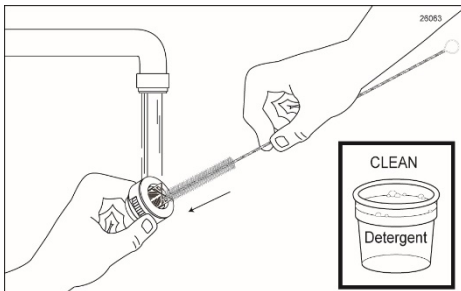

4. Brush and clean all exposed surfaces of the Blending Head with detergent water, then rinse thoroughly with warm water (108°F / 42°C). Use a small brush to ensure the syrup orifices are completely clear.

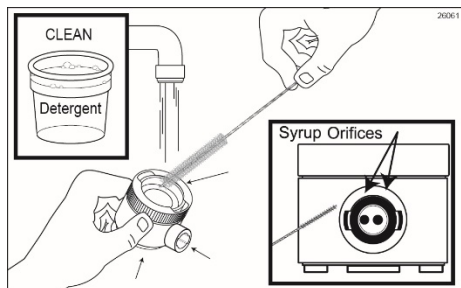

5. When the Gear Box and nut have soaked for at least 5 minutes, brush and clean all exposed surfaces and openings with detergent water and rinse thoroughly with warm water (108°F / 42°C).

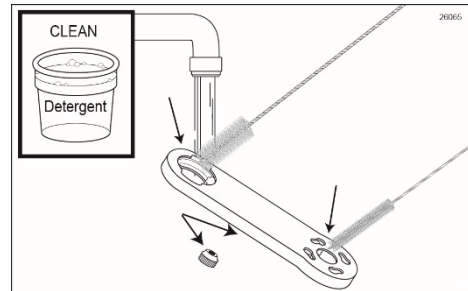

NOTE: UNDER NORMAL OPERATING CONDITIONS, IT IS NOT ADVISORY TO BRUSH OTHER AREAS INSIDE THE GEAR BOX. DOING SO MAY CAUSE DAMAGE.

NOTE: DO NOT OPEN OR DISASSEMBLE THE GEAR BOX.

6. Remove the o-rings from the adapter body. Brush and clean the parts with detergent water. Then rinse thoroughly with warm water (108°F / 42°C).

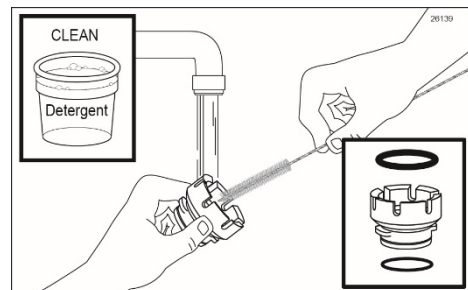

7. Submerge the Gear Box, nut, Gear Cartridge, Blending Head, spout adapter, and o-rings in the sanitizer solution and soak for at least 5 minutes.

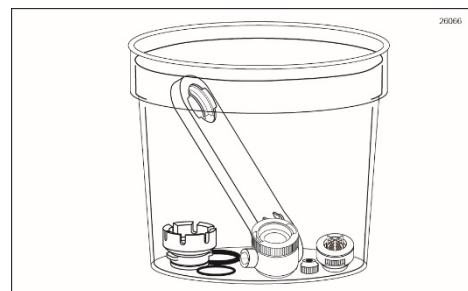

8. Remove each part from the sanitizer solution. Place the items on a sanitary tray to air dry.

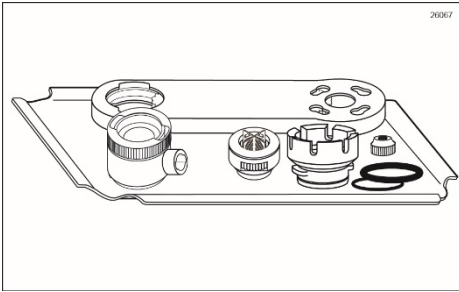

9. Spray the syrup line manifold opening with the sanitizer solution. Allow it to sanitize for at least 5 minutes.

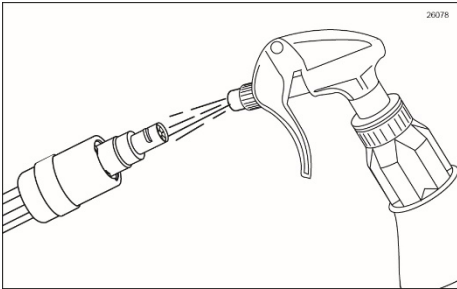

10. Dry the end of the manifold with a clean single service towel.

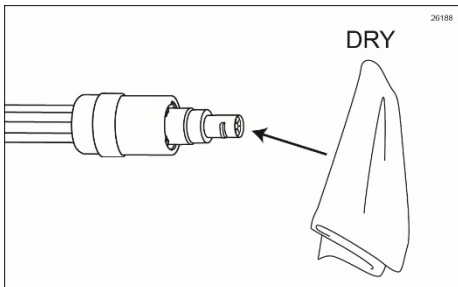

11. Install the cap on the manifold.

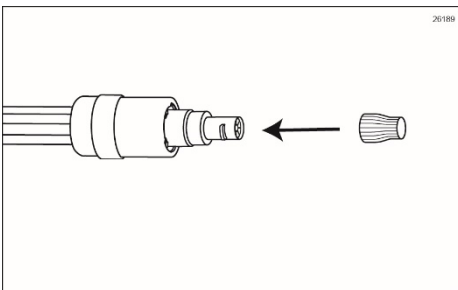

12. Clean, rinse and dry the surfaces of the Drive Motor and exposed surfaces of the cabinet using detergent water, warm water (108°F / 42°C), and single service towels.

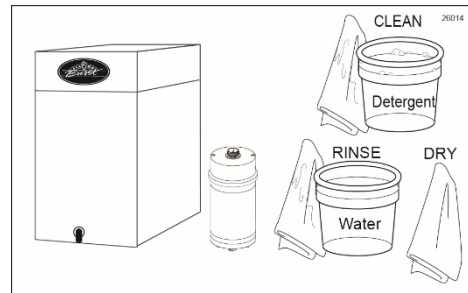

13. The following do not need to be sanitized on a daily basis. However, inspect these areas and if necessary, clean according to instructions in the SCHEDULED MAINTENANCE section:

- Touch Panel and Mounting Bracket
- 9-Tube Assembly Coupler
- 9-Tube Assembly Tubes

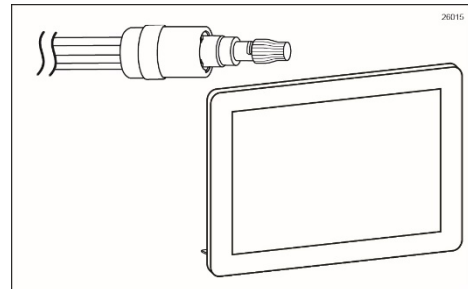

REPLACING THE SYRUP FLAVORS

NOTE: BE SURE TO PLACE A CONTAINER UNDER THE BLENDING HEAD TO CATCH THE PRODUCT AND SANITIZER SOLUTION.

NOTE: YOUR HANDS SHOULD BE CLEANED AND SANITIZED BEFORE YOU PERFORM THE FOLLOWING PROCEDURE.

NOTE: THE FOLLOWING PROCEDURES REQUIRE APPROVED, SERVICEABLE AND SANITIZED TOOLS AND BRUSHES. CONTACT WHITE GLOVE SERVICE FOR RECOMMENDED SUPPLIES.

NOTE: USE STERA-SHEEN® GREEN LABEL SANITIZER AND DAWN® DISH SOAP MIXED WITH WARM WATER (108°F / 42°C) FOR THE FOLLOWING PROCEDURES. REFER TO MANUFACTURER'S INSTRUCTIONS FOR PROPER PREPARATIONS OF THESE CLEANING AGENTS.

NOTE: INSPECT ALL WEAR ITEMS AND REPLACE IF NECESSARY.

Each syrup flavor is stored inside a numbered tray (1-4) within the system cabinet. Under normal operating conditions, flavors are installed as previous flavors become empty. However, you may change flavors periodically as desired.

1. Prepare detergent water by mixing several drops of Dawn® dish soap with a gallon of warm water (108°F / 42°C). Prepare sanitizer solution by mixing half a packet (1 oz) of Stera-Sheen® Green Label with one gallon of warm water (108°F / 42°C) until dissolved. Pour approximately 16 oz. of sanitizer solution into a spray bottle and set aside the rest.
2. Place a cup or container under the spout.

3. Disconnect the syrup line connector from the syrup bag.

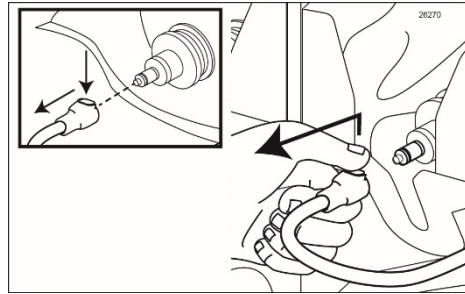

4. Locate the Pump Flush Adapter under the bottom trays and connect it to the syrup bag connector.

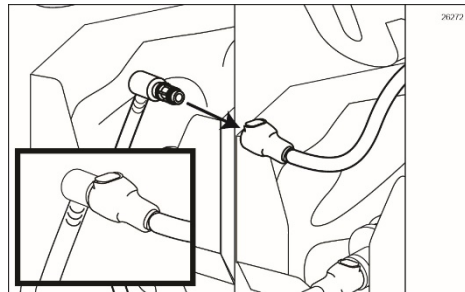

5. Press and hold the center logo on the Touch Panel to access the Flavor Burst Maintenance Menu. If the screen asks for a password, enter the password.
6. Scroll down to the Maintenance Functions section and touch the key named "Flushing Functions".



- Press the flavor of the line to be flushed and follow the instructions outlined on the Touch Panel screen to flush the syrup line.

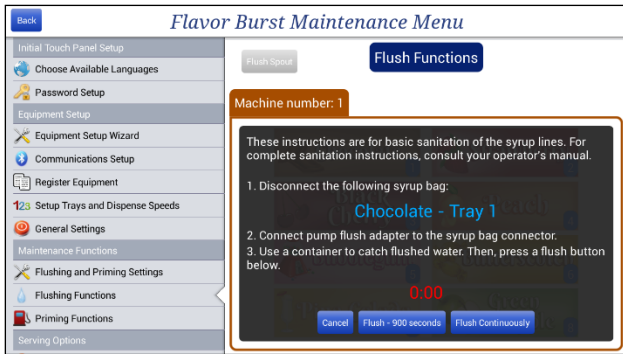

NOTE: LINE TO FLUSH FOR THE FULL 15 MINUTES TO COMPLY WITH SANITATION GUIDELINES.

- While the line is flushing, pull the tray forward and remove the syrup bag. Discard the syrup bag if it is empty or expired. If the bag has usable syrup, store the syrup as directed on the label.

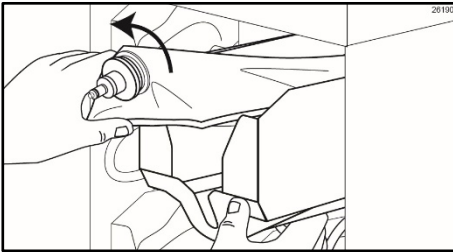

- Clean the syrup tray with detergent water, rinse with warm water (108°F / 42°C), and dry with a single service towel.

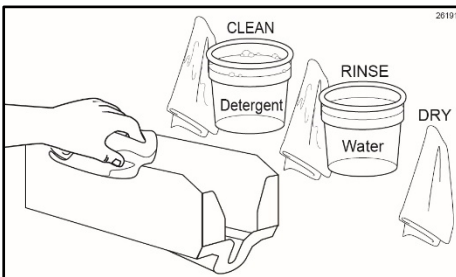

- Select the flavor you wish to use, then place the bag on the table with the fitment up and remove the dust cap.

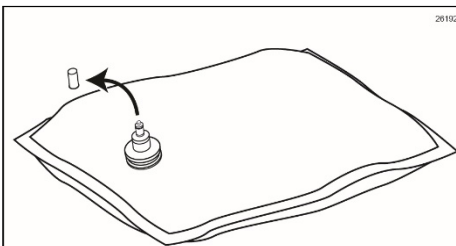

- Lifting up with the bag fitment, press the center pin of the bag fitment valve and gently press on the bag to release any excess air.

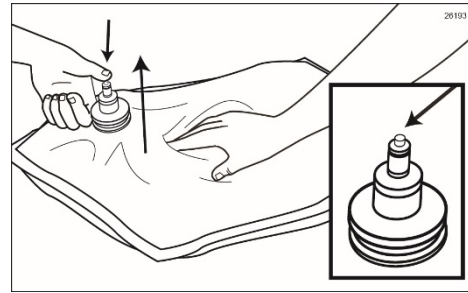

- Grip the bag underneath the fitment and lift the bag up, with your other hand supporting the bottom of the bag. Flip the fitment end over into the open end of the tray, while guiding the back end of the syrup bag into the back end of the syrup tray.

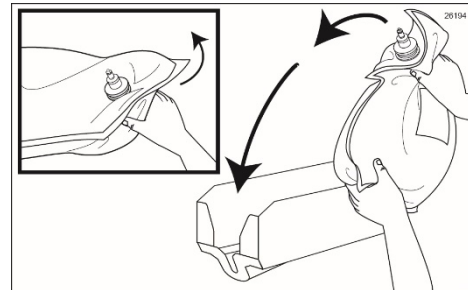

- Settle the bag into the tray evenly, with the fitment behind the tray opening.

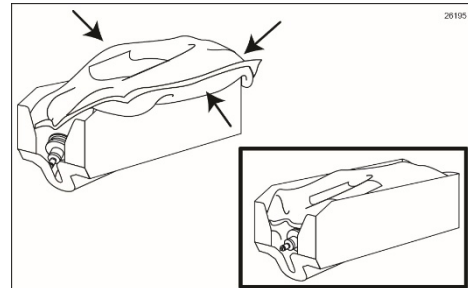

- Make sure the syrup bag is settled neatly into the tray, and then install the loaded tray into the cabinet.

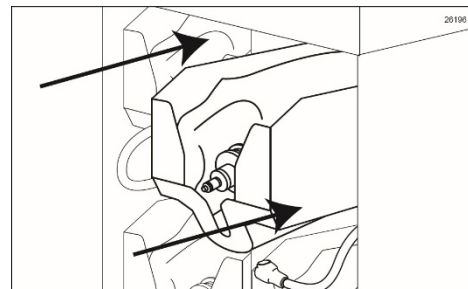

15. Once the flushing process has completed, disconnect Pump Flush nozzle from the syrup bag connector. Return the Pump Flush Adapter to its place in the cabinet.

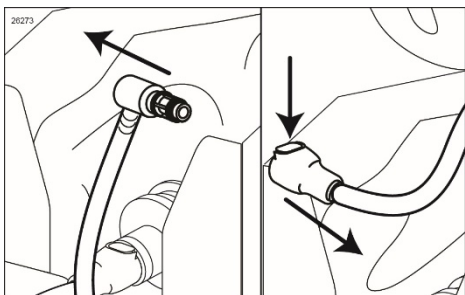

16. Clean the exposed surfaces of the syrup bag connector and bag fitment with detergent water, single service towel and brush if necessary. Then rinse them with warm water (108°F / 42°C) and dry with single service towels.

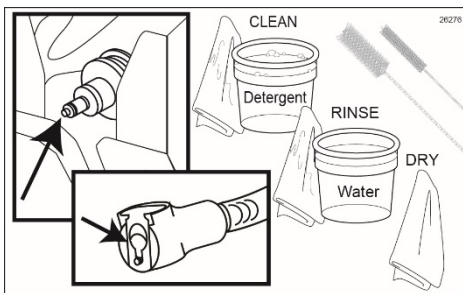

17. Using the spray bottle with the sanitizer solution, spray the syrup bag fitment and the syrup bag connector. Allow these parts to sanitize for at least 5 minutes.

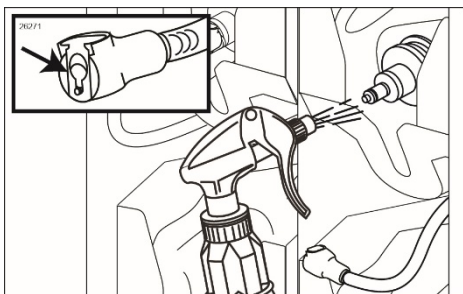

18. Connect the syrup bag connector to the syrup bag fitment.

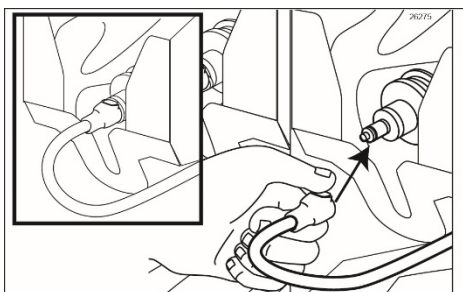

19. Repeat Steps 3-18 for any additional flavors that are being changed out.
20. After the line is sanitized, select “Priming Functions” in the Maintenance Menu.
21. Select the flavor button of the line to be primed. The button will pulse as syrup is pumped through the line.



22. When the syrup flowing from the spout is thick and undiluted, press a flavor key again to stop the prime function.

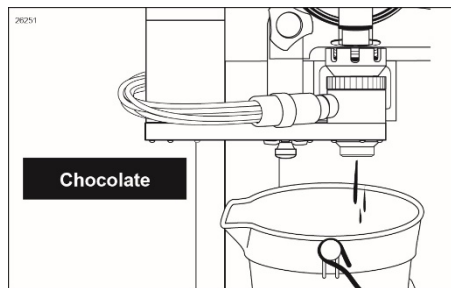

23. Repeat Steps 21 and 22 to prime any other new syrup bags that have been installed.

24. When all the syrup lines with replaced flavors have been primed, go to “Flushing Functions” in the Maintenance Menu and press FLUSH SPOUT to clean the spout.

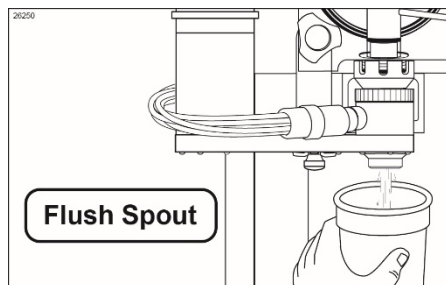

NOTE: TO CHANGE THE FLAVOR BUTTONS ON THE MENU SCREEN, GO TO THE “SETUP TRAYS AND DISPENSE SPEEDS” OF THE MAINTENANCE MENU AND PRESS ANY FLAVOR DESCRIPTION TO EDIT THE NAME.

PAGE INTENTIONALLY LEFT BLANK

SCHEDULED MAINTENANCE

The following procedures are performed less frequently than daily or as needed.

NOTE: YOUR HANDS SHOULD BE CLEANED AND SANITIZED BEFORE YOU PERFORM THE FOLLOWING PROCEDURES.

NOTE: THE FOLLOWING PROCEDURES REQUIRE APPROVED, SERVICEABLE AND SANITIZED TOOLS AND BRUSHES. CONTACT WHITE GLOVE SERVICE FOR RECOMMENDED SUPPLIES.

NOTE: USE FLO-SAN® SANITIZER, STERA-SHEEN® GREEN LABEL SANITIZER, AND DAWN® DISH SOAP MIXED WITH WARM WATER (108°F / 42°C) FOR THE FOLLOWING PROCEDURES. REFER TO MANUFACTURER'S INSTRUCTIONS FOR PROPER PREPARATIONS OF THESE CLEANING AGENTS.

NOTE: INSPECT ALL WEAR ITEMS AND REPLACE IF NECESSARY.

NOTE: OPERATE UNIT UNDER NORMAL AMBIENT TEMPERATURES BETWEEN 60 AND 80 DEGREES FAHRENHEIT. UNIT SHOULD NEVER BE EXPOSED TO FREEZING TEMPERATURES.

Clean-In-Place (CIP) Procedure

The Clean-In-Place procedure should be performed every 30 days to ensure that the syrup passageways are free of any product crystallization. The medium used for this process must be the approved sanitizing products Flo-San® and Stera-Sheen® Green Label mixed according to the product manufacturer's instructions. This Clean-In-Place procedure is detailed in four phases:

- (1) Prep
- (2) Flush
- (3) Clean
- (4) Reassemble

To ensure maximum results, the following instructions should be completed in sequence as stated. This will expose the system and parts to the sanitizing medium for about 130 minutes.

CIP - Phase 1: Prep

1. Disconnect the sanitizer tank from the sanitizer line.

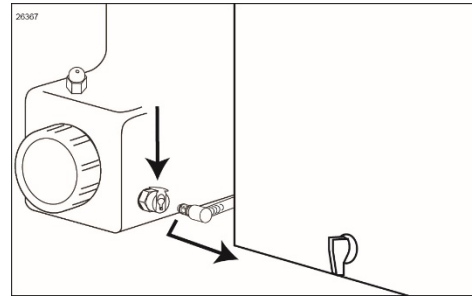

2. Remove the sanitizer tank's cap and discard any remaining Flo-San sanitizer solution. Rinse out the tank with water.

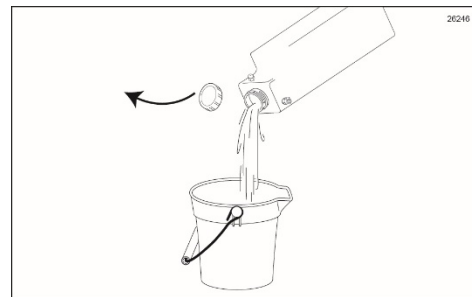

3. Mix two packets (4 oz total) of Stera-Sheen® Green Label with four gallons of warm water (108°F / 42°C) until dissolved. Fill the sanitizer tank to the top fill line. Pour approximately 16 oz. of sanitizer solution into a spray bottle and set aside the rest for sanitizing parts in Step 19.

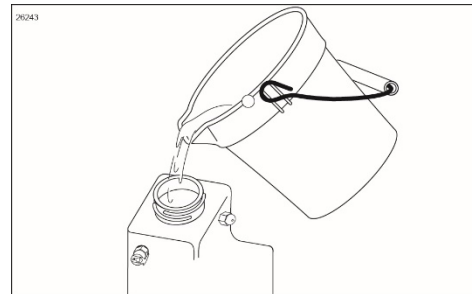

NOTE: IF YOUR TANK RUNS OUT OF SOLUTION DURING THE CIP PROCESS, REFILL IT USING THE EXCESS STERA-SHEEN SOLUTION OR MIX A NEW BATCH USING HALF A PACKET OF STERA-SHEEN AND 1 GALLON OF WARM-HOT WATER.

- Reinstall the cap and tighten sufficiently.

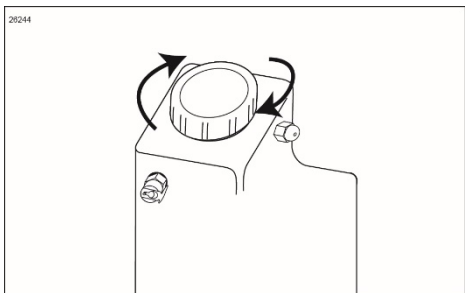

- Connect the tank to the cabinet using the sanitizer line.

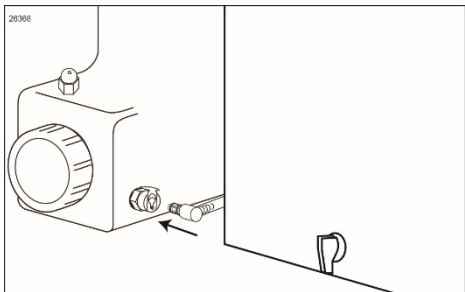

- Prepare detergent water by mixing several drops of Dawn® dish soap with a gallon of warm water (108°F / 42°C).

- Rotate the 9-Tube Assembly coupler until it unlocks and remove it from the Blending Head syrup line opening.

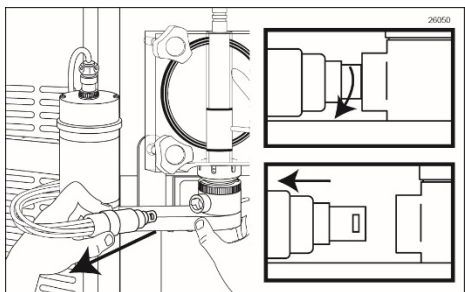

- Unlock the coupler body by rotating it from the coupler base. Remove the coupler body, syrup line manifold, and duckbill check valve from the 9-Tube Assembly. Submerge these parts in detergent water.

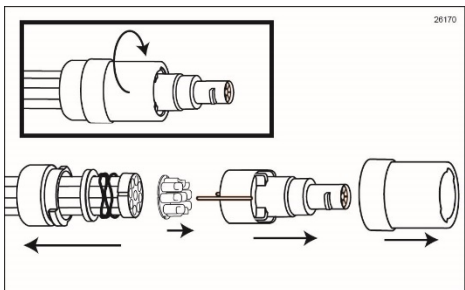

- Place the end of the 9-Tube Assembly into a container to catch the expelled syrup and sanitizer solution during the rest of the Clean-In-Place procedure.

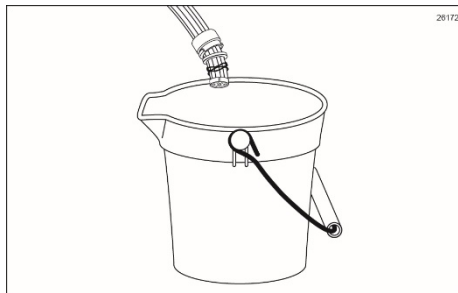

- Disconnect the syrup bag connectors from the syrup bags.

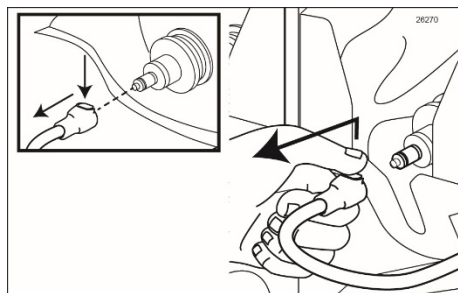

- Remove the Blending Assembly and adapter from the freezer and disassemble them. Submerge the Blending Head, Gear Cartridge, Gear Box, nut, spout adapter, and o-rings in detergent water with the 9-Tube Assembly. Set aside the Drive Motor.



NOTE: DO NOT SOAK THE DRIVE MOTOR OR EXPOSE IT TO EXCESS WATER.

CIP - Phase 2: Flush

NOTE: THE FOLLOWING CLEAN-IN-PLACE PROCEDURE SHOULD BE COMPLETED CONSECUTIVELY, BEGINNING WITH SYRUP LINE #1 UNTIL ALL FOUR SYRUP LINES HAVE BEEN FLUSHED.

12. Locate the Pump Flush Adapter under the bottom tray and connect it to the first syrup bag connector.

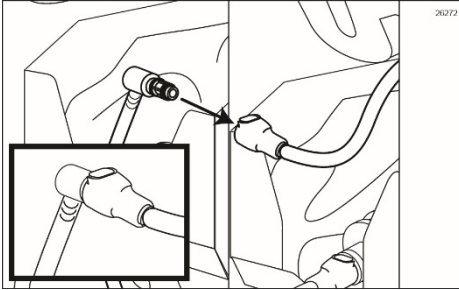

13. Press and hold the center logo on the Touch Panel to access the Flavor Burst Maintenance Menu. If the screen asks for a password, enter the password.
14. Scroll down and touch the section named "Flushing Functions".

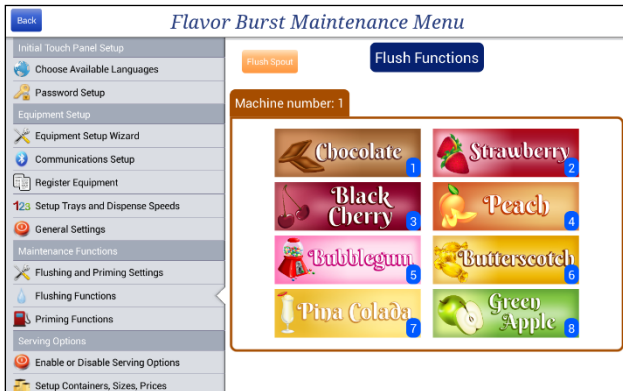

15. Touch the flavor of the line that will be flushed and follow the instructions outlined on the Touch Panel screen to flush the syrup line.

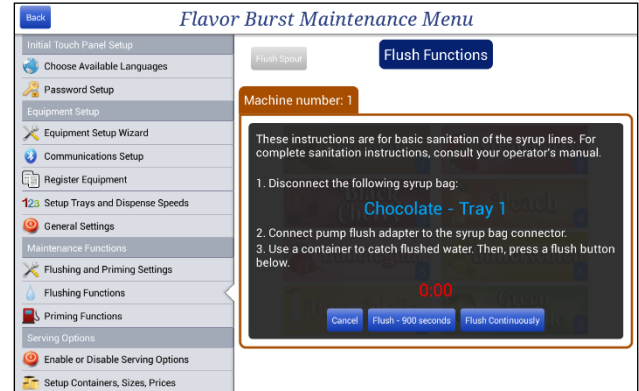

16. When the flushing process is complete, disconnect the Pump Flush Adapter and repeat the process for the second line, then the third, and so on until all the lines have been flushed. While the lines are flushing, proceed to "Phase 3: Clean" to make the most of your time.

NOTE: THE FLUSH FUNCTION SHOULD CONTINUE FOR 15 MINUTES. YOU MAY CANCEL THE FLUSH PROCEDURE AT ANY TIME BY TOUCHING THE "CANCEL" KEY. HOWEVER, THE SYSTEM **MUST COMPLETE A FULL 15 MINUTE FLUSH PROCESS FOR EACH SYRUP LINE** IN ORDER TO COMPLY WITH SANITATION GUIDELINES.

17. When all lines have been flushed, disconnect the Pump Flush Adapter, return it to its place under the bottom tray, and return the screen to the main menu.

CIP – Phase 3: Clean

18. Brush and clean the Gear Box, nut, Blending Head, Gear Cartridge, spout adapter, o-rings, syrup line manifold, manifold cap, duckbill check valve, and coupler body with warm detergent water. Be sure that each of the 9 individual check valves and the Blending Head orifices are cleaned thoroughly by brushing through each valve and orifice opening. Rinse thoroughly with warm water (108°F / 42°C).

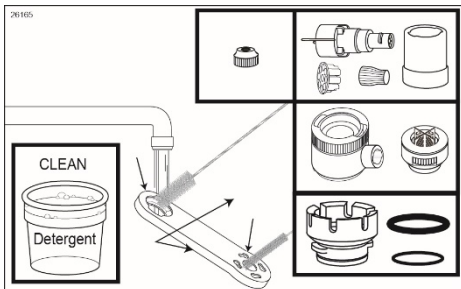

NOTE: DO NOT OPEN OR DISASSEMBLE THE GEAR BOX.

19. Submerge the parts in Stera-Sheen Green Label sanitizer solution for at least 5 minutes.



20. Remove the rest of the parts from the sanitizer solution and place them on a sanitary tray to dry.

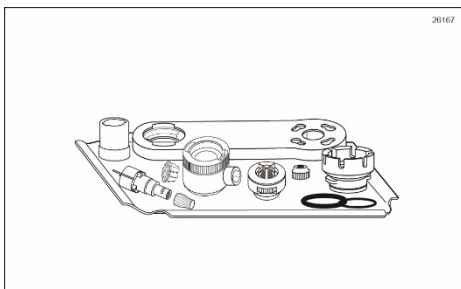

21. Clean the exposed surfaces of the bag fitment and the syrup bag connector with warm-hot detergent water. Brush the bag fitment with the medium brush and the Connector with the small brush. Then rinse with warm water (108°F / 42°C) and dry the parts with single service towels.

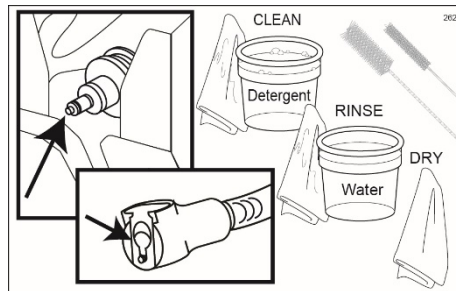

22. Using the spray bottle of sanitizer solution, spray the exposed surfaces of the bag fitment and the syrup bag connector. Let the solution sanitize these parts for at least 5 minutes.

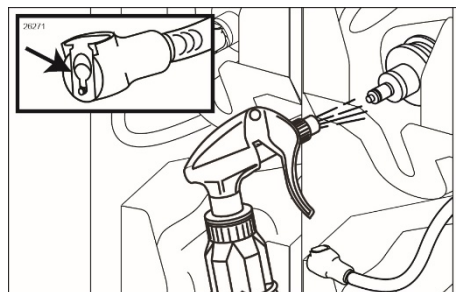

23. Remove the end of the 9-Tube Assembly from the container. Spray end of the assembly with sanitizer solution and allow it to sanitize for at least 5 minutes.

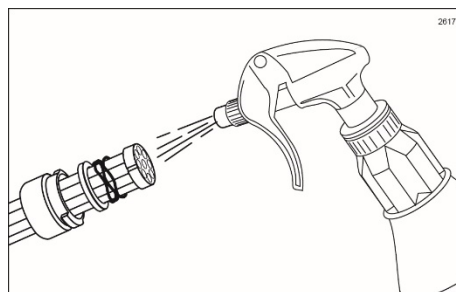

CIP - Phase 4: Reassemble

24. Reconnect the syrup lines and bags of syrup by pressing the syrup bag connector onto the bag valve.

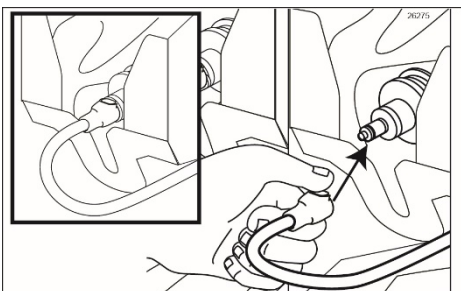

25. Install the duckbill check valve into the syrup line manifold and the syrup line manifold into the coupler body.

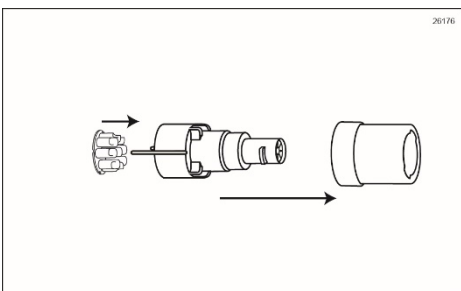

26. Carefully align the pins of the syrup line manifold with the syrup line connector and insert the end of the 9-Tube Assembly fully into the Coupler.

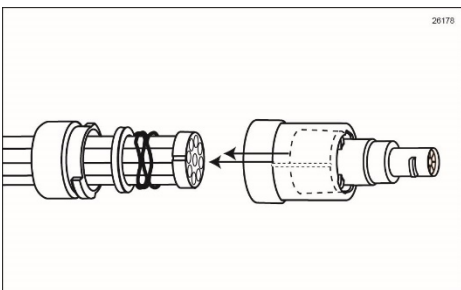

27. Push the coupler nut into the coupler body and rotate the coupler body until motion stops to secure.

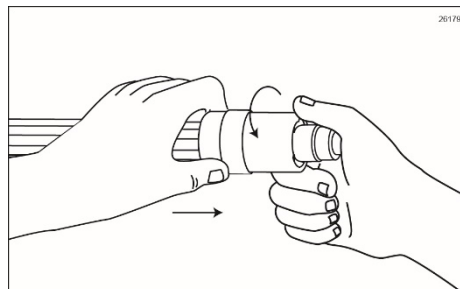

28. Install the cap on the manifold.

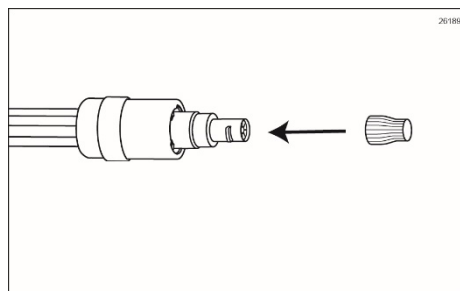

29. Perform the “Assembling the Blending Assembly” and “Installing the Blending System” sections of the DAILY OPENING PROCEDURES.

30. Empty and discard the remaining Stera-Sheen sanitizer solution from the tank. Rinse it out with water. Refill the sanitizer tank with Flo-San sanitizer in the following section “Refilling the Sanitizer Tank”.

31. Prime the syrup system as instructed in “Priming the Syrup System.”

Refilling the Sanitizer Tank

For day-to-day operations, use Flo-San® sanitizer mixed according to the manufacturer's instructions in the sanitizer tank. The tank system delivers solution to specific areas of the Flavor Burst® system such as the Blending Head and syrup lines during certain functions. Therefore, check the tank levels on a daily basis. For proper sanitation, use only FRESH sanitizer solution in the tank that is no more than 28 days old. Replace older solution with fresh sanitizer solution.

1. Disconnect the sanitizer tank from the sanitizer line.

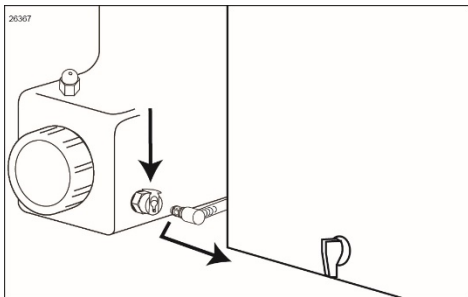

2. Remove the sanitizer tank's cap and discard any remaining Flo-San sanitizer solution. Rinse out the tank with water.

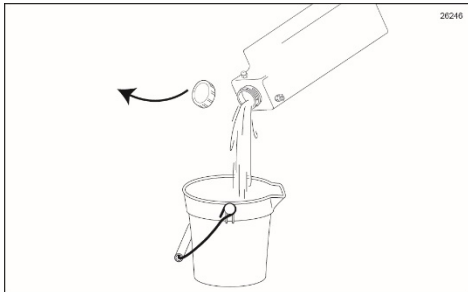

3. Mix one packet (0.50 oz) of Flo-San® with two gallons of warm water (108°F / 42°C) until dissolved. Pour the sanitizer solution into the tank.

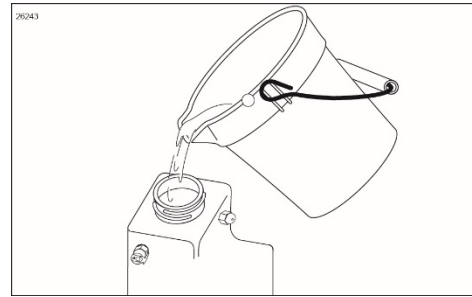

4. Reinstall the cap and tighten sufficiently.

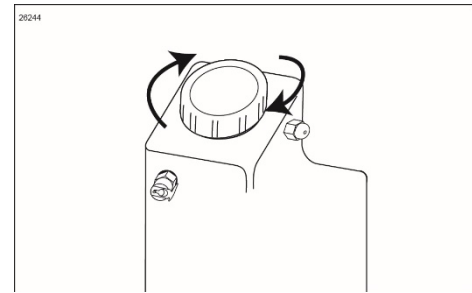

5. Connect the tank to the cabinet using the sanitizer line.

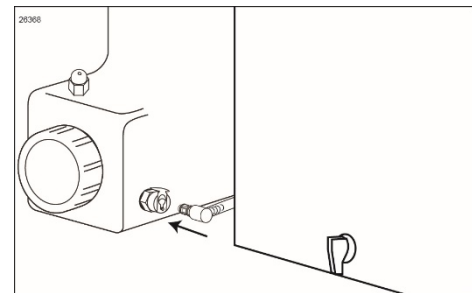

Priming the Syrup System

Priming the syrups is necessary when first installing the flavors, after the Clean-In-Place procedure, when an individual flavor or multiple flavors remain idle for more than 72 hours, and when changing flavors. Only the syrup lines directly involved will require this process.

1. Press and hold the center logo on the Touch Panel to access the Flavor Burst Maintenance Menu. If the screen asks for a password, enter the password.
2. Select “Priming Functions” in the Maintenance Menu.
3. Select the syrup line to be primed, and follow the instructions on the screen. The button will pulse as syrup is pumped through the line.



4. When the syrup flowing from the spout is thick and undiluted, press a flavor key again to stop the prime function.

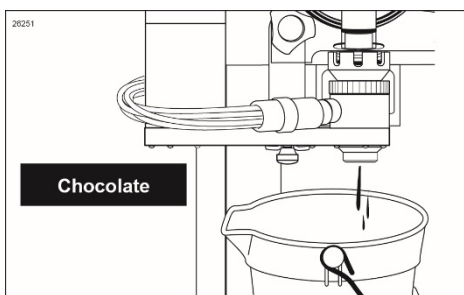

5. Repeat Steps 3 and 4 to prime any other flavors that have been changed.

6. When all the syrup lines with replaced flavors have been primed, go to “Flushing Functions” in the Maintenance Menu and press FLUSH SPOUT to clean the spout.

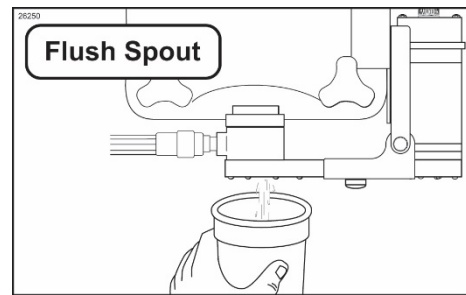

NOTE: TO CHANGE THE FLAVOR BUTTONS ON THE MENU SCREEN, GO TO THE “SETUP TRAYS AND DISPENSE SPEEDS” OF THE MAINTENANCE MENU AND PRESS ANY FLAVOR DESCRIPTION TO RENAME.

Replacing Blending Head O-Rings

The Blending Head o-rings are wear items and will need to be replaced periodically. Always keep spares of these items on hand in the Spare Parts Kit for replacement.

1. Prepare detergent water by mixing several drops of Dawn® dish soap with a gallon of warm water (108°F / 42°C). Prepare sanitizer solution by mixing half a packet (1 oz) of Stera-Sheen® Green Label with one gallon of warm water (108°F / 42°C) until dissolved.
2. Remove the worn o-rings from the Blending Head. A small tool may be needed to remove the two o-rings in the syrup line opening.

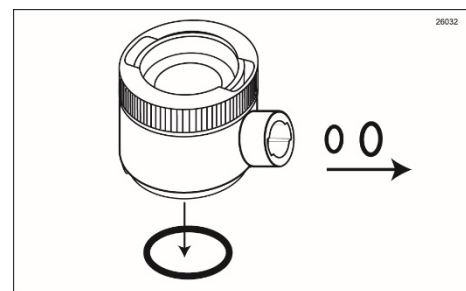

- Brush and clean all exposed surfaces of the Blending Head with detergent water. Use a small brush to ensure that the syrup orifices are clear of any residual syrup.

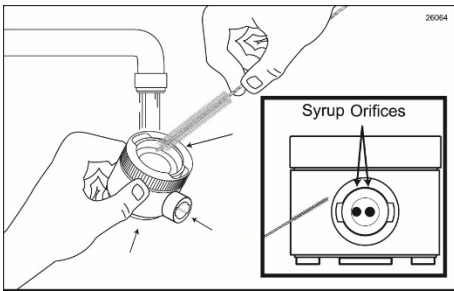

- Submerge the Blending Head and the new replacement o-rings in sanitizer solution for at least 5 minutes.

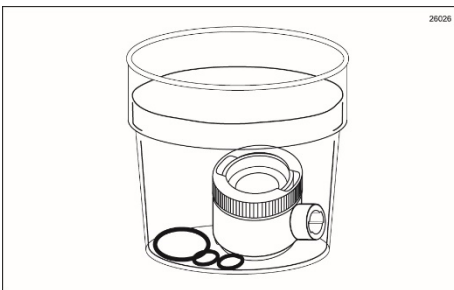

- Remove the o-rings and Blending Head and place them on a sanitary tray to dry.

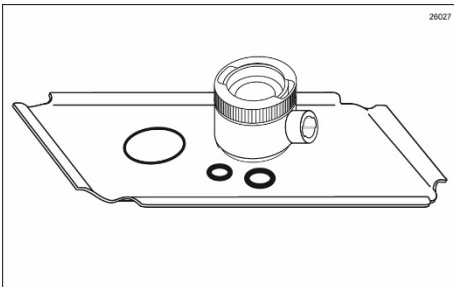

- Place the larger o-ring into the groove on the underside of the Blending Head.

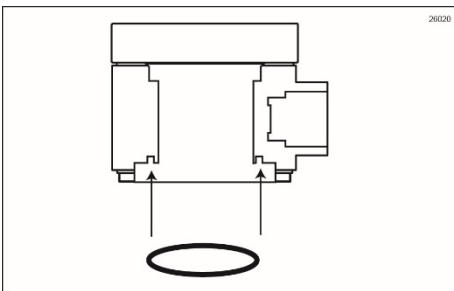

- Apply food-grade lube to the two syrup port o-rings and then place them into their respective places inside the syrup port. A small tool may be used to ensure the o-rings are fully seated in the grooves.

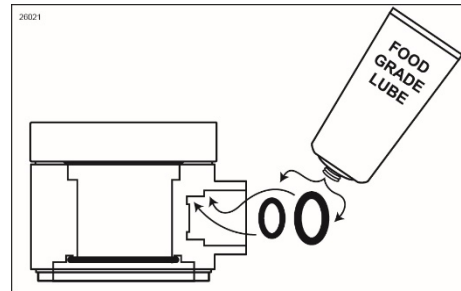

NOTE: O-RINGS MUST BE COMPLETELY SEATED TO PREVENT LEAKAGE.

Miscellaneous Cleaning Procedures

The following parts of the STL-40BLD-JR do not require daily cleaning. Inspect these areas periodically and clean if necessary according to instructions.

Prepare detergent water by mixing several drops of Dawn® dish soap with a gallon of warm water (108°F / 42°C). Prepare sanitizer solution by mixing half a packet (1 oz) of Stera-Sheen® Green Label with one gallon of warm water (108°F / 42°C) until dissolved. Pour approximately 16 oz. of sanitizer solution into a spray bottle and set aside the rest.

NOTE: DO NOT USE AN EXCESSIVE AMOUNT OF WATER OR DETERGENT IN CLEANING THE OUTSIDE OR INSIDE OF THE CABINET.

Cleaning the Blending Assembly Suspension Bracket

The Blending Assembly suspension bracket is installed behind the freezer door. Therefore, it is only removed to be sanitized when the freezer barrel is empty. The bracket must be cleaned and sanitized at least every 30 days, preferably when the Clean-In-Place procedure is performed. Follow these instructions to clean and sanitize the suspension bracket.

NOTE: YOU CAN USE THIS OPPORTUNITY TO CLEAN THE FREEZER BARREL AND ITS PARTS ACCORDING TO MANUFACTURER'S INSTRUCTIONS.

1. Ensure the freezer barrel is empty. If the freezer has multiple barrels, ensure all barrels are empty before proceeding.
2. Remove the door knobs from the freezer door.

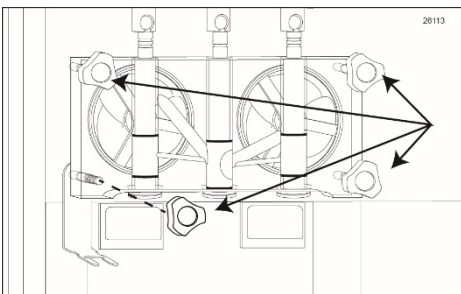

3. Remove the freezer door from the freezer.

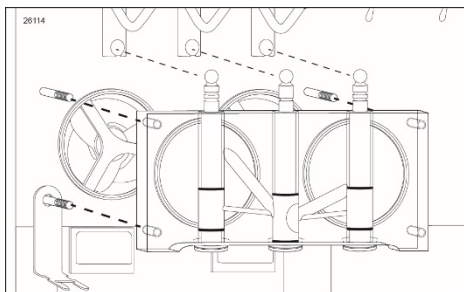

4. Remove the suspension bracket from the freezer door post.

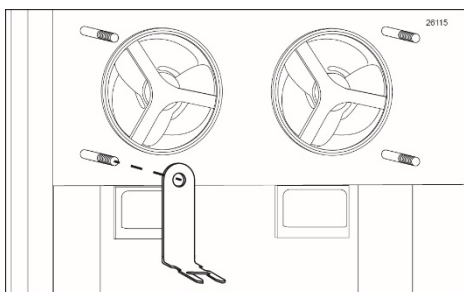

5. Clean the bracket parts using detergent water and brush if necessary, then rinse thoroughly with warm water (108°F / 42°C).

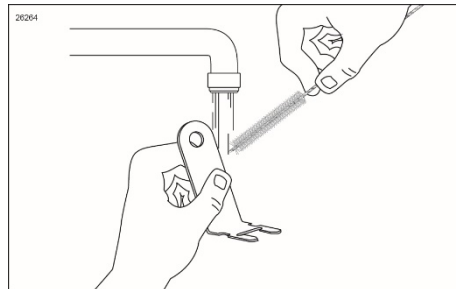

6. Submerge the bracket in sanitizer solution for at least 5 minutes.

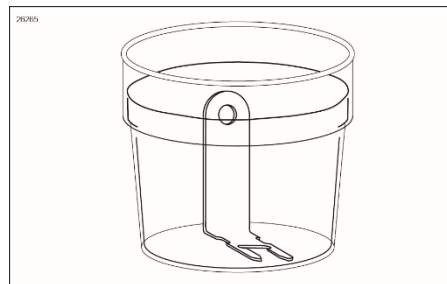

7. Remove parts from the sanitizer solution and place them on a sanitary tray to dry.

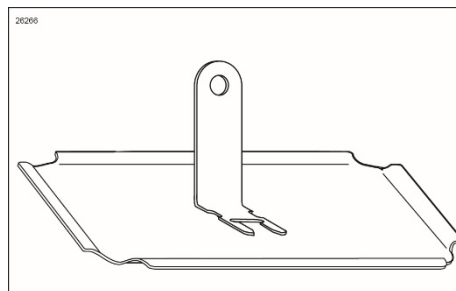

8. Install the bracket back onto the freezer door post.

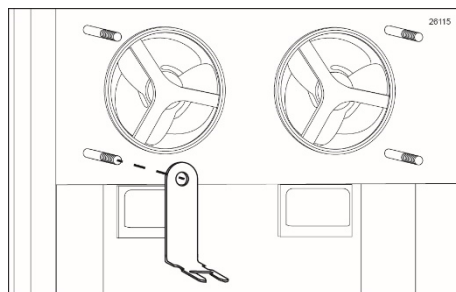

9. Reinstall the freezer door.

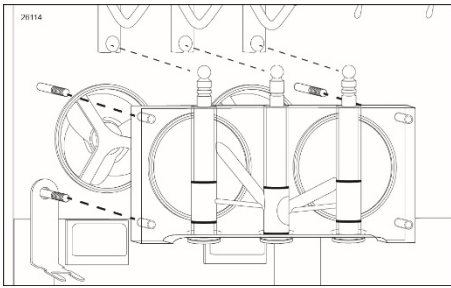

10. Install and tighten the freezer door knobs.

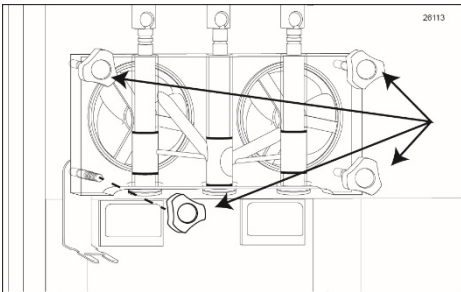

Area Under the Cabinet

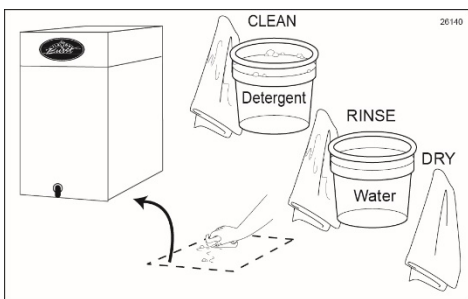

1. Carefully move the cabinet to an area outside of where it was sitting.
2. Clean the area using a single service towel moistened with warm detergent water. Use a brush if necessary.
3. Rinse area with a single service towel and warm water (108°F / 42°C) and then wipe dry with a dry single service towel.
4. Clean the outside and underside of the cabinet using detergent, water and single service towels.
5. Carefully return the cabinet to its original place.

Inside of the Cabinet

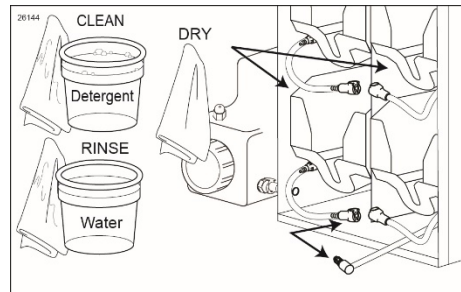

1. If necessary, disconnect the syrup bag connectors from the bags and remove the syrup trays for better access.
2. Using warm detergent water and single service towels, clean any exposed surface inside the cabinet.
3. Rinse the cleaned surfaces with warm water (108°F / 42°C) and a single service towel.
4. Dry the surfaces with a single service towel.
5. Clean, rinse and dry the trays if necessary using detergent, warm water (108°F / 42°C), and single service towels. Also clean and sanitize the syrup bag connectors according to instructions in the Clean-In-Place procedure in the SCHEDULED MAINTENANCE section.

Tube / Cable Casing Assemblies

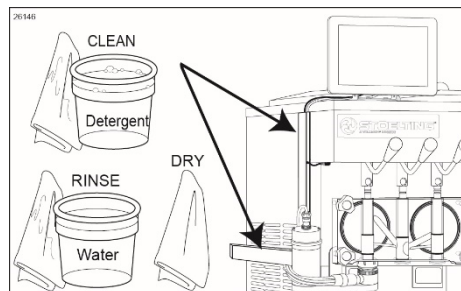

1. Remove the metal casing from the freezer.
2. Using warm detergent water and a single service towel, clean the metal casing and the plastic casing attached to the freezer.
3. Rinse casings with a towel and warm water (108°F / 42°C).
4. Dry the casings with a single service towel.
5. Reinstall the metal casing to the freezer.

9-Tube Assembly Syrup Lines

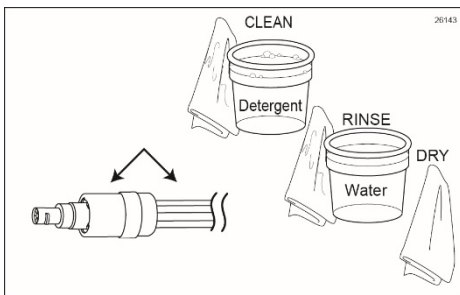

1. If it is necessary, follow instructions in 'Phase 1' and 'Phase 3' of the Clean-In-Place procedure to clean and sanitize the coupler body, syrup line manifold, and the duckbill check valve.
2. Clean the coupler base, the end of the manifold and the outside of the syrup tubes with a towel and detergent water.
3. Rinse the parts using a single service towel and warm water (108°F / 42°C), then dry with a towel.
4. Reassemble the 9-Tube Assembly if necessary according to instructions in 'Phase 4' of the Clean-In-Place procedure.

Touch Panel and Mounting Bracket

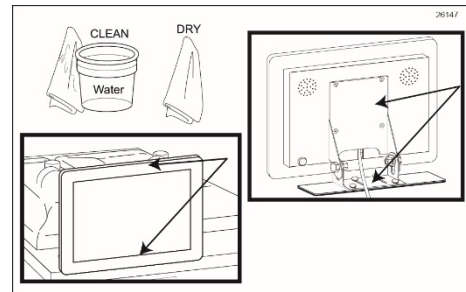

NOTE: DO NOT GET WATER NEAR THE CABLE CONNECTIONS OR SPEAKER HOLES ON THE TOUCH PANEL.

NOTE: DO NOT USE ANY HARSH CHEMICAL CLEANERS, BLEACH, AMMONIA, EXCESS WATER, BRUSHES OR ABRASIVE TOOLS TO CLEAN THE SURFACE OF THE TOUCH PANEL. THESE MAY DAMAGE THE SURFACE OF THE SCREEN AND VOID THE PANEL'S WARRANTY.

1. Turn the Touch Panel off by pressing the power button on the back side of the Panel.
2. Use only clean soft cloths, such as micro-fiber cloths, to clean the Touch Panel surfaces. Dampen a soft cloth with warm water (108°F / 42°C). Wring out any excess moisture from the cloth.
3. Gently wipe the surfaces of the Touch Panel and mounting bracket to remove dust, dirt, fingerprints, etc.
4. Gently wipe the cables with the dampened cloth, taking care not to get any moisture near cable connections and any openings on the Touch Panel.
5. Use the dry soft cloth to dry the surfaces of the Touch Panel and cables.

Winterizing the Unit

If you will not be using your Flavor Burst[®] system during the off-season or other extended periods of time, you should winterize the STL-40BLD-JR system as a precautionary practice to avoid damage or undesirable syrup build-up in the unit.

NOTE: YOU DO NOT NEED TO USE ANTIFREEZE SOLUTION IN THIS SYSTEM WHEN WINTERIZING THE UNIT.

1. Perform the first three CIP procedure sections. Do not perform the “CIP- Phase 4: Reassemble” section.
2. Reassemble the 9-Tube Assembly with the coupler body, duckbill check valve and manifold.

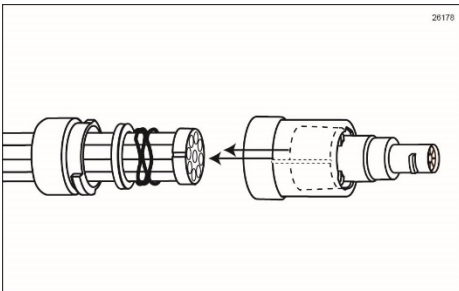

3. Place the 9-Tube Assembly line inside a container.

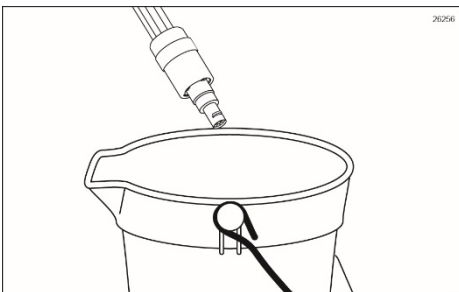

4. Remove each syrup bag from its tray and store as directed on the label.

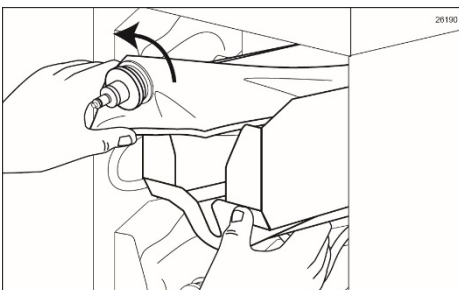

5. Empty the sanitizer tank and return the tank to the unit.

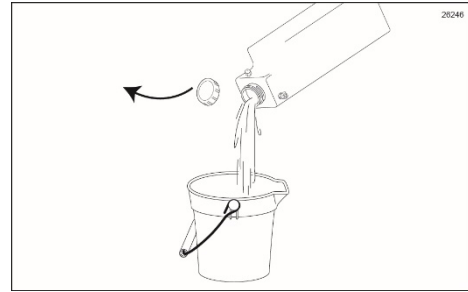

6. With the sanitizer tank empty, press the FLUSH SPOUT button until all sanitizer solution is removed from the sanitizer line.

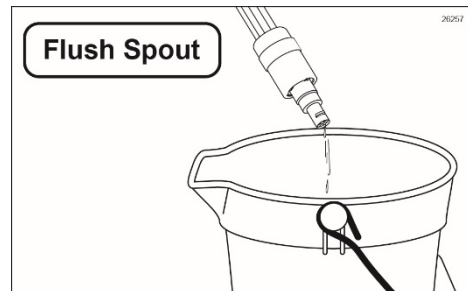

NOTE: IF NO “FLUSH SPOUT” BUTTON IS DISPLAYED ON THE SCREEN, YOU CAN USE THE FLUSH SPOUT BUTTON IN THE “FLUSH FUNCTIONS” SECTION OF THE MAINTENANCE MENU.

7. Connect the Pump Flush Adapter to the first syrup line.

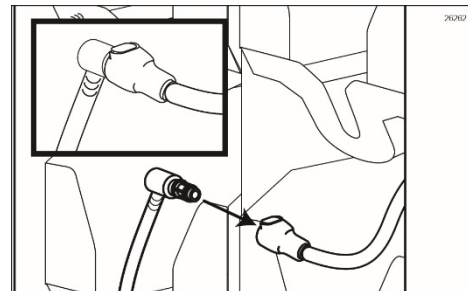

8. Press and hold the center logo on the Touch Panel to access the Flavor Burst Maintenance Menu. If the screen asks for a password, enter the password.

- Scroll down to the Maintenance Functions section and touch the key named “Flushing Functions”.

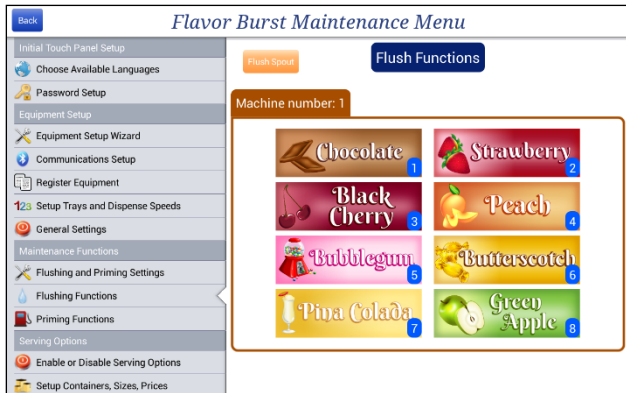

- Press the flavor line to be flushed and follow the instructions outlined on the Touch Panel to flush the syrup line until it is empty.

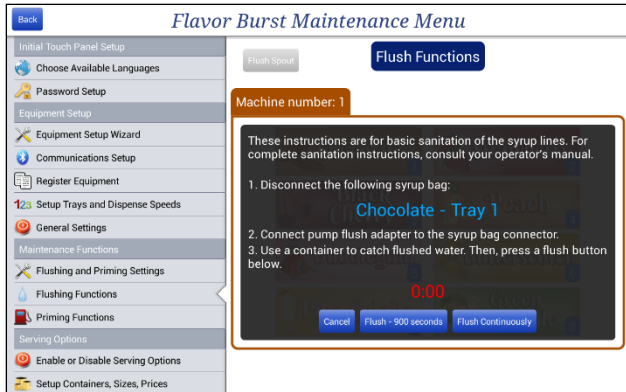

- When the line is empty, press CANCEL and disconnect the Pump Flush Adapter. Connect the Pump Flush Adapter to the next bag connector.

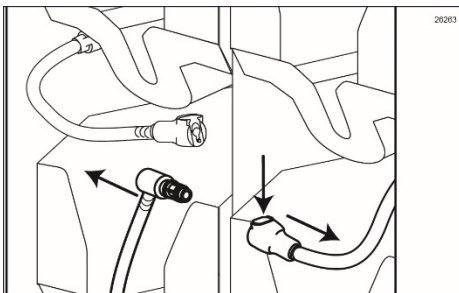

NOTE: THE FLUSH FUNCTION WILL CONTINUE FOR 15 MINUTES. YOU MAY STOP IT AT ANY TIME BY PRESSING “CANCEL”.

- Repeat Steps 10 and 11 for the second line, then the third, and so on until all the lines have been cleared of sanitizer solution.

- When all lines have been emptied, return the Pump Flush Adapter to the position under the trays.

- Ensure the Blending Assembly and the other parts are stored in a sanitary place for the off-season. When opening next season, be sure to perform the Clean-In-Place procedure again to sanitize all pumps before recharging the system with syrups.

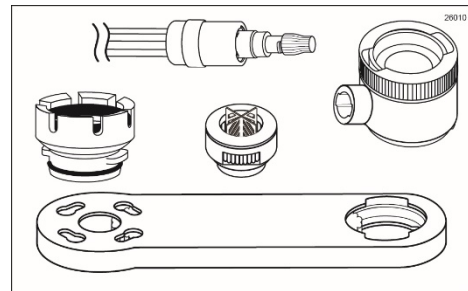

- When opening next season, be sure to perform the Clean-In-Place procedure again to sanitize all pumps before recharging the system with syrups.

PAGE INTENTIONALLY LEFT BLANK

EQUIPMENT SETUP

NOTE: YOUR HANDS SHOULD BE CLEANED AND SANITIZED BEFORE YOU PERFORM THE FOLLOWING PROCEDURES.

NOTE: INSPECT ALL WEAR ITEMS AND REPLACE IF NECESSARY.

NOTE: THE FOLLOWING PROCEDURES REQUIRE APPROVED, SERVICEABLE AND SANITIZED TOOLS AND BRUSHES. CONTACT YOUR LOCAL DISTRIBUTOR FOR RECOMMENDED SUPPLIES.

NOTE: USE STERA-SHEEN® GREEN LABEL SANITIZER AND DAWN® DISH SOAP MIXED WITH WARM WATER (108°F / 42°C) FOR THE FOLLOWING PROCEDURES. REFER TO MANUFACTURER'S INSTRUCTIONS FOR PROPER PREPARATIONS OF THESE CLEANING AGENTS.

NOTE: THE SYSTEM IS NOT TO BE USED BY PERSONS (INCLUDING CHILDREN) WITH REDUCED PHYSICAL, SENSORY OR MENTAL CAPABILITIES, OR LACK OF EXPERIENCE AND KNOWLEDGE, UNLESS THEY HAVE BEEN GIVEN SUPERVISION OR INSTRUCTION.

NOTE: CHILDREN ARE TO BE SUPERVISED WHEN USING THE SYSTEM AND SHALL NOT PLAY WITH THE SYSTEM.

NOTE: INSTALL THE SYSTEM WHERE AMBIENT TEMPERATURES ARE BETWEEN 60 AND 80 DEGREES FAHRENHEIT FOR CORRECT OPERATION.

NOTE: INSTALL THE SYSTEM IN A LOCATION WHERE ITS USE AND MAINTENANCE IS RESTRICTED TO TRAINED PERSONNEL.

RECOMMENDED BASE PRODUCT: FOR BEST BLENDING RESULTS, USE A BASE MIX THAT CONTAINS 5% OR LESS BUTTERFAT.

RECOMMENDED DRAW RATE: SLOW THE FREEZER DRAW RATE TO DISPENSE PRODUCT AT 1/2 OZ PER SECOND. THIS GIVES THE SYSTEM PROPER TIME TO BLEND, RESULTING IN MORE EVEN COLOR AND FLAVOR.

Installing the Touch Panel and Mounting Bracket

The Touch Panel is the control unit for the Flavor Burst® system. Normal operating functions are performed using the Touch Panel and the freezer draw handle. The Touch Panel is mounted to the top of the freezer with the Touch Panel mounting bracket.

NOTE: IF YOUR FREEZER HAS A ROUNDED TOP, CONTACT WHITE GLOVE SERVICE FOR ALTERNATE MOUNTING KITS.

1. Prepare detergent water by mixing several drops of Dawn® dish soap with a gallon of warm water (108°F / 42°C).
2. Determine where you wish to mount the Touch Panel. It is typically mounted in the middle of the freezer, centered above the middle spout on a multi-barrel freezer, or centered above the spout with the Flavor Burst assembly attached (as shown in these instructions). Clean the top surface of the freezer where the mounting bracket will be attached, between the front edge and the hopper with detergent water. Rinse the area with warm water (108°F / 42°C) and dry with a single service towel.

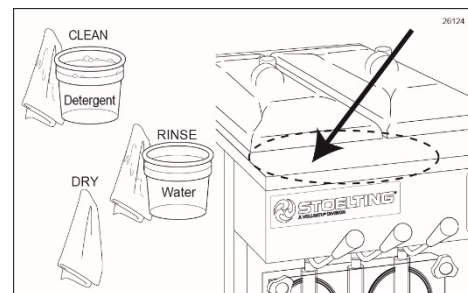

NOTE: THE SURFACE MUST BE FREE FROM DUST AND OILS OR THE ADHESIVE WILL NOT CURE PROPERLY.

- Use the ampule provided to prime the cleaned area before mounting the Touch Panel mounting bracket.

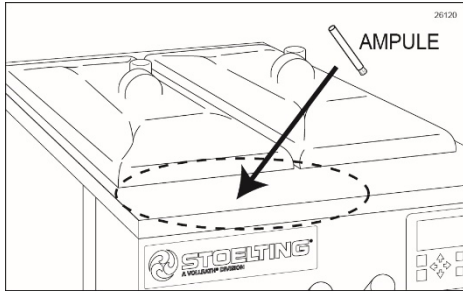

NOTE: LIQUID INSIDE THE AMPULE ENHANCES ADHESION.

- Set the mounting plate on the freezer where it will be attached. Measure and mark with a pencil around the base plate.

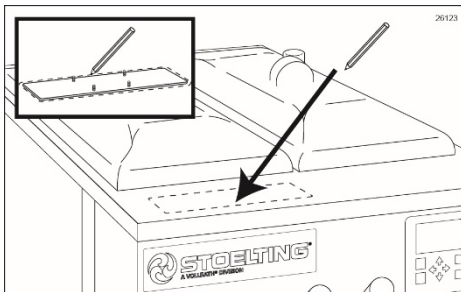

- Remove the protective covering from the adhesive strip on the bottom of the base plate. **The front of the plate is the side with the posts that are closest together.** Apply the base plate to the freezer within the pencil marks. Press firmly and allow the adhesive to cure for at least 1 hour.

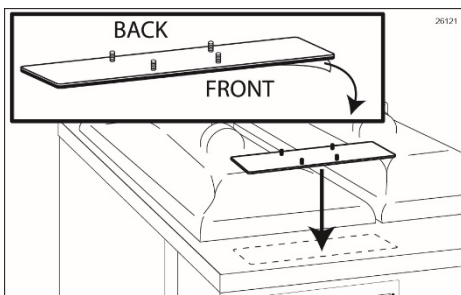

NOTE: IF THE ADHESIVE DOES NOT HAVE TIME TO CURE PROPERLY, THE CONSTANT WEIGHT OF THE TOUCH PANEL CAN PULL THE ADHESIVE AWAY FROM THE FREEZER SURFACE. THIS COULD EVENTUALLY RESULT IN THE TOUCH PANEL ASSEMBLY FALLING OFF THE FREEZER.

- Install the Touch Panel mounting plate to the back of the Touch Panel using the screws provided. Use the small lock washers in between the plate and screws.

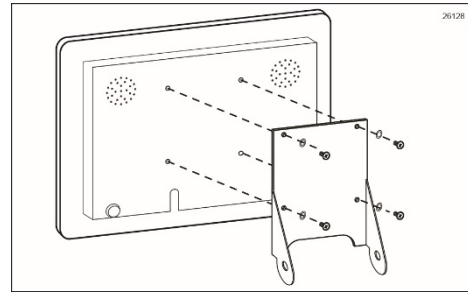

- Connect the ethernet cable to the "DRIVER BOARD 1" ethernet port behind the Touch Panel screen.

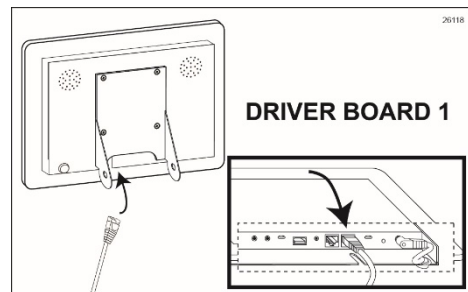

NOTE: WHILE "DRIVER BOARD 2" PORT IS ALSO A VALID PORT, IT IS TEMPORARILY PLUGGED TO AVOID CONFUSION. THE COLOR TOUCH PANEL PROGRAM DEFAULTS TO DRIVER BOARD 1.

- Connect the straight end of the switch extension to the "PORT 1" switch port behind the Touch Panel screen.

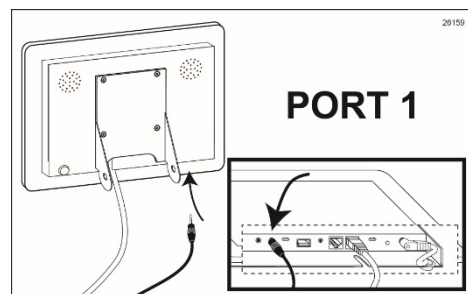

NOTE: WHILE "PORT 2" SWITCH PORT IS ALSO A VALID PORT, IT IS TEMPORARILY PLUGGED TO AVOID CONFUSION. YOU WILL ACTIVATE THE PORT YOU USE WHEN YOU GO THROUGH THE EQUIPMENT SETUP WIZARD PROGRAM ON YOUR COLOR TOUCH PANEL LATER.

- Place the anchor bracket within the arms of the Touch Panel plate so that the flat end of the anchor bracket extends away from the front of the Touch Panel.

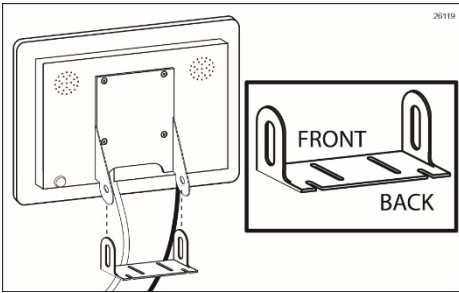

- Insert the hex bolts through the Touch Panel plate arms from the outside, through the upright slots of the anchor bracket. Secure the bolts with the lock nuts with the washers between the nuts and the bracket.

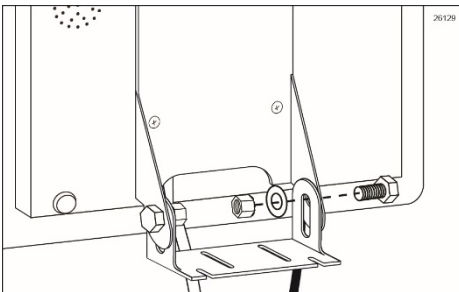

- After the base plate has had an hour to cure, mount the Touch Panel and bracket assembly to the base plate. Use the hand knobs to attach the assembly to the posts of the base plate and tighten them to secure.

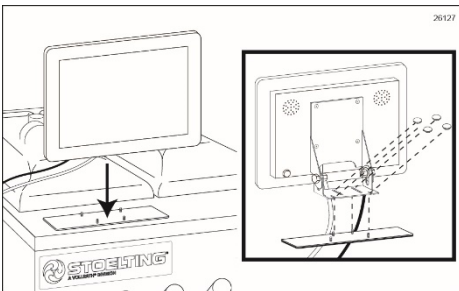

- To position the Touch Panel closer or further from the freezer operator, loosen the base plate hand knobs and slide the assembly forward or backward. Ensure the anchor bracket is secured to all four posts of the base plate. Tighten the hand knobs to secure the desired position.

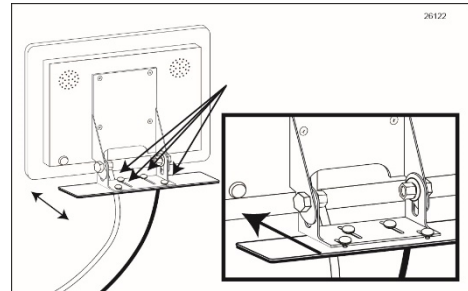

NOTE: IF THE BACK SLOTS OF THE ANCHOR BRACKET ARE NOT SECURED TO THE BASE PLATE, THE TOUCH PANEL MAY PUT TOO MUCH WEIGHT ON THE FRONT OF THE ASSEMBLY, CAUSING THE ASSEMBLY TO BECOME UNSTABLE OR LOOSEN FROM THE FREEZER.

- To adjust the height or angle of the Touch Panel, loosen the hex bolts and lock nuts and move the Touch Panel into the desired position. Tighten the bolts to secure.

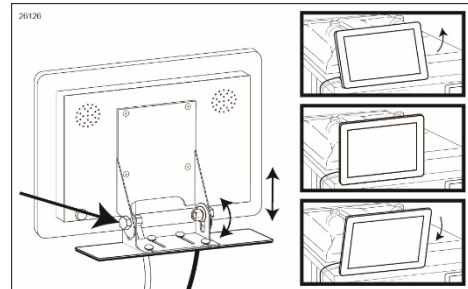

- Thread the ethernet cable through the mounting bracket and back behind the freezer.

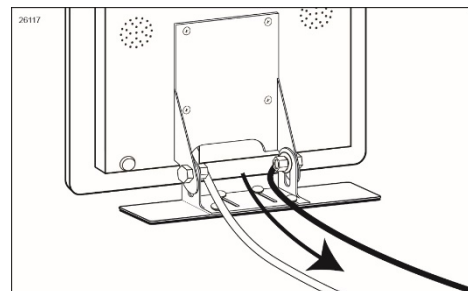

Draw Switch Options

When the draw spout is activated, the switch relays the signal to the Flavor Burst® system, telling it to activate the pumps and syrups as product is drawn from the spout. The STL-40BLD-JR includes two options for the draw switch.

PREFERRED METHOD: The draw switch extension should be used with freezers with an integrated switch already installed. If your freezer does not have an integrated switch, contact [White Glove Service](#) to order and install the integrated switch kit #2209616.

OPTIONAL METHOD: The other option is a draw handle switch. It is included in the Spare Parts Kit for freezers lacking the internal switch.

Installing the Draw Switch Extension

The draw switch extension is used with freezers with an integrated switch already installed. This is the recommended switch setup.

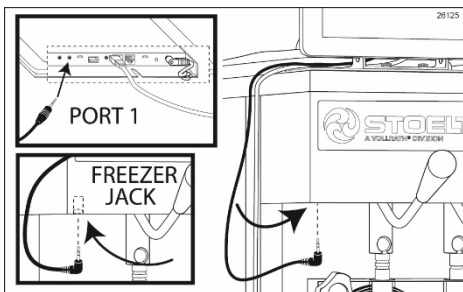

1. Ensure the straight end of the switch extension is connected to the “PORT 1” switch port on the underside of the Touch Panel.

NOTE: WHILE “PORT 2” SWITCH PORT IS ALSO A VALID PORT, IT IS TEMPORARILY PLUGGED TO AVOID CONFUSION. YOU WILL ACTIVATE THE PORT YOU USE WHEN YOU GO THROUGH THE EQUIPMENT SETUP WIZARD PROGRAM ON YOUR COLOR TOUCH PANEL LATER.

2. Connect the angled-end of the switch extension to the switch jack underneath the freezer overhang, near the draw handle.
3. Ensure the connections are fully engaged.

Installing the Draw Handle Switch

The draw handle switch is used when there is no integrated switch in the freezer, the integrated freezer switch or extension malfunctions, or when troubleshooting a problem. The draw handle switch is located inside the Spare Parts Kit.

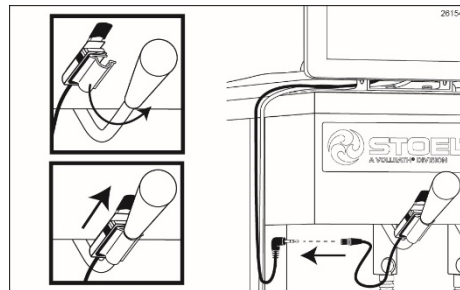

1. Ensure the straight end of the switch extension is connected to the “PORT 1” switch port on the underside of the Panel.

NOTE: WHILE “PORT 2” SWITCH PORT IS ALSO A VALID PORT, IT IS TEMPORARILY PLUGGED TO AVOID CONFUSION. YOU WILL ACTIVATE THE PORT YOU USE WHEN YOU GO THROUGH THE EQUIPMENT SETUP WIZARD PROGRAM ON YOUR COLOR TOUCH PANEL LATER.

2. Clip the draw handle switch onto the handle and slide it up the handle until the switch is within grasping range.
3. Connect the switch extension to the draw switch jack and ensure the connection is fully engaged.

NOTE: IF YOUR FREEZER DOES NOT HAVE AN INTERNAL SWITCH JACK AND THE SPARE DRAW HANDLE SWITCH DOES NOT FIT YOUR FREEZER, CONTACT [WHITE GLOVE SERVICE](#) FOR MORE OPTIONS. WHEN POSSIBLE, ORDER AND INSTALL THE INTEGRATED SWITCH KIT #2209616.

Sanitizing the Blending System

If the Blending Assembly is already assembled, disassemble it before proceeding.

1. Prepare sanitizer solution by mixing half a packet (1 oz) of Stera-Sheen® Green Label with one gallon of warm water (108°F / 42°C) until dissolved. Pour approximately 16 oz. of sanitizer into a spray bottle.
2. Remove the o-rings from the spout adapter. Submerge the Gear Box, nut, Gear Cartridge, spout adapter, o-rings, suspension bracket, and Blending Head in sanitizer solution and soak for 5 minutes.

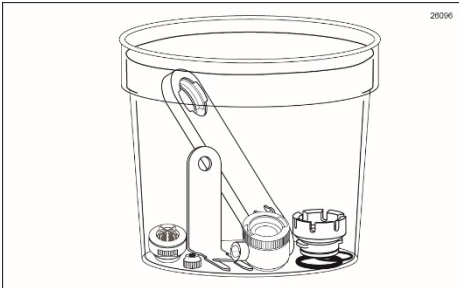

3. Remove the cap and spray the cap and syrup line manifold opening with approved sanitizer solution. Allow them to sanitize for at least 5 minutes.

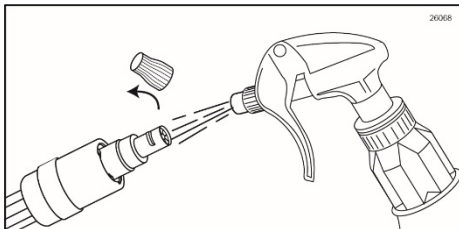

4. Place the 9-Tube Assembly and manifold cap on a sanitary tray to dry. Remove the parts from the sanitizer solution and place them on the tray to air dry.

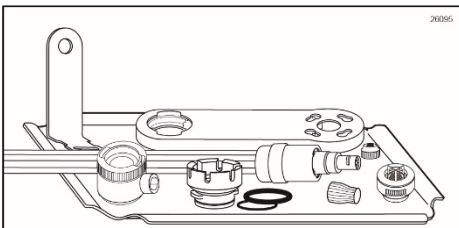

Assembling the Blending Assembly

1. Place the Gear Cartridge into the Gear Box so that the gear teeth line up with the gear inside the Gear Box.

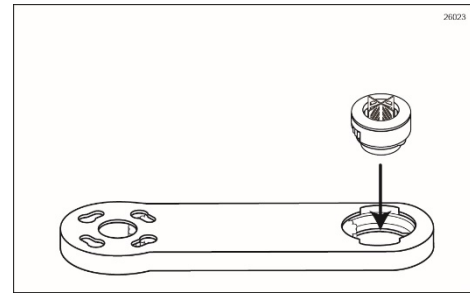

2. Install the Blending Head onto the Gear Box and rotate off-center to secure.

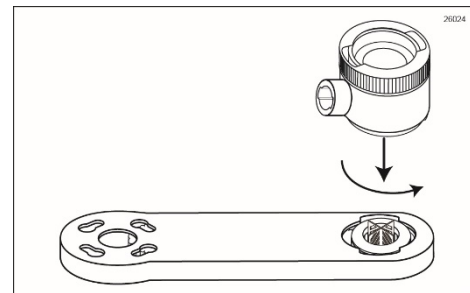

3. Insert the Drive Motor into the Gear Box so that all four locking screws are fully seated. Rotate the motor clockwise to secure.

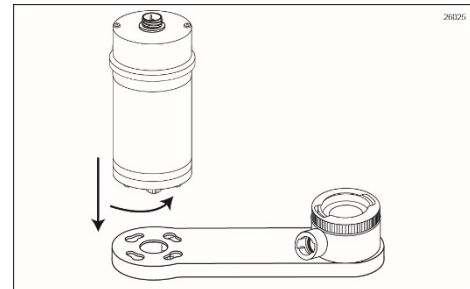

Installing the Spout Adapter

Every STL-40BLD-JR system ships with an adapter that attaches to the spout of the freezer. The STOEADPT500FBA spout adapter fits most Stoelting freezers. It has two o-rings. Always keep extra o-rings in the Spare Parts Kit as they are wear items.

Additional adapters may be available from [White Glove Service](#) for use with other Stoelting models. See the ALTERNATE PARTS AND KITS BY FREEZER MODEL section for more information.

1. Ensure the freezer door spout is clean and sanitized according to the freezer manufacturer's instructions.
2. Install the o-rings in their proper positions on the adapter body.

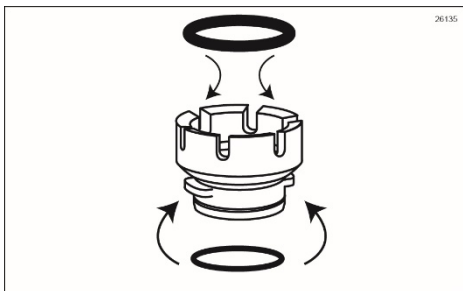

3. Install the spout adapter assembly, complete with o-rings, onto the freezer spout. Push up on the adapter with your palm until it snaps on. Ensure it is evenly and fully installed.

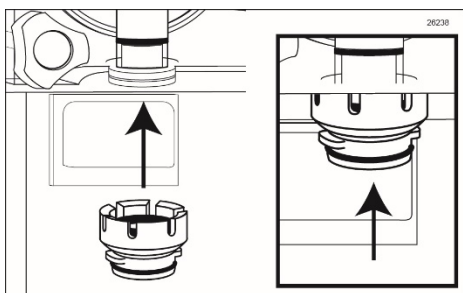

Installing the Blending System and Suspension Bracket

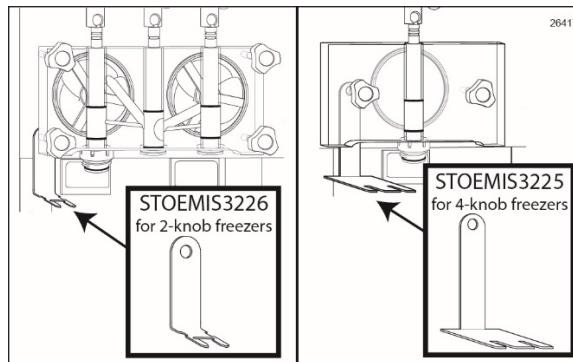

The suspension bracket helps stabilize the Blending Assembly on the freezer. When properly installed on the freezer, the bracket should hold the Blending Assembly level horizontally, with the Blending Head lined up directly under the spout adapter. Two different suspension brackets are included with this system: one for freezer doors with four knobs / posts, and one for freezer doors with two knobs / posts. Additional suspension bracket styles may be available for other freezer models through [White Glove Service](#).

The Blending Assembly can be mounted to either side of the freezer spout. The 9-Tube Assembly may also come from either side, regardless of the Blending Assembly's position. Images below show installation on a 4-knob/post freezer with multiple barrels.

RECOMMENDED POSITIONING:

- (A) When possible, install the Blending Assembly on the opposite side of the 9-Tube Assembly's placement. Placing the Drive Motor end of the assembly opposite from the 9-Tube Assembly makes it easier to attach and remove the 9-Tube Assembly when cleaning.
- (B) If there are vents on the side of the freezer that blow out warm air, install the 9-Tube Assembly on the opposite side. The air could warm the syrup and affect the look of the soft serve product when served. Installing the 9-Tube Assembly on a side that does not have vents blowing air will keep the syrup cool and product consistent.

1. Determine how the Blending Assembly will be positioned on the freezer. When possible, follow the recommended position outlined above.

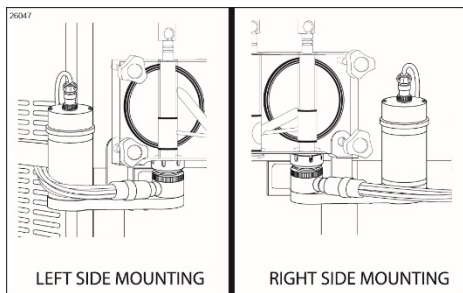

2. Ensure the freezer barrel is empty before proceeding. If the freezer has multiple barrels, ensure all barrels are empty before proceeding. The suspension bracket is installed behind the freezer door.
3. Remove the door knobs from the freezer door.

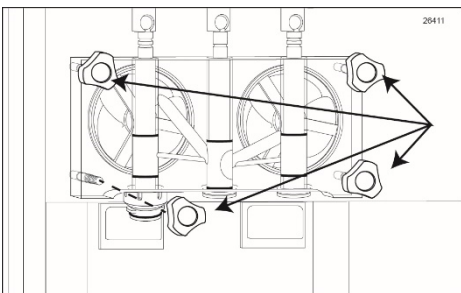

4. Remove the freezer door from the freezer.

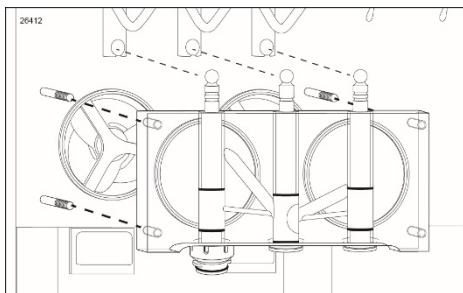

5. Install the bracket back onto the freezer door post. The bracket should be installed on the post closest to where the Drive Motor of the assembly will be.

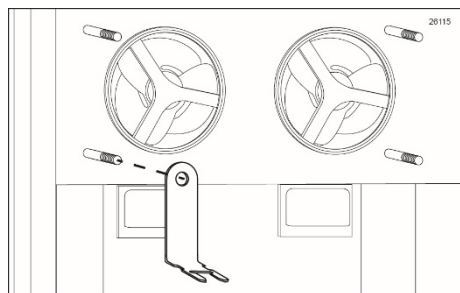

6. Reinstall the freezer door.

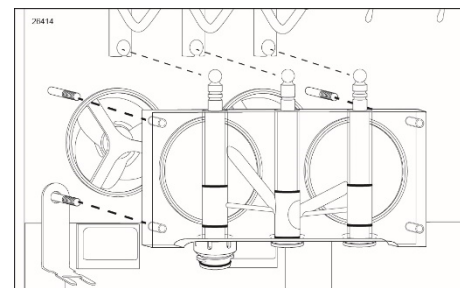

7. Install and tighten the freezer door knobs.

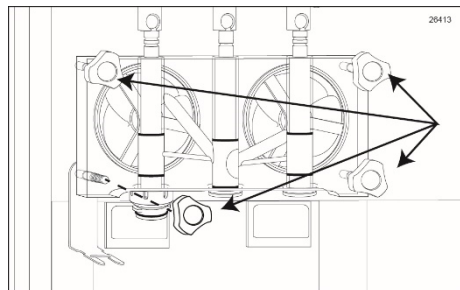

8. For freezer doors with only two knobs and posts, the installation process is the same.

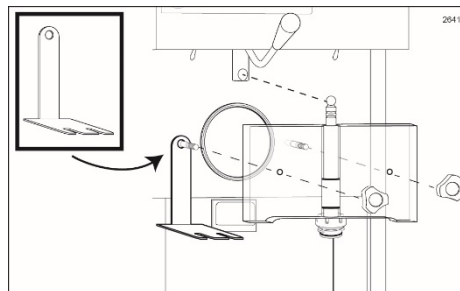

9. Place the Blending Assembly onto the suspension bracket, so that the Gear Box post slides into the bracket opening. Install the Blending Head fully over the spout adapter.

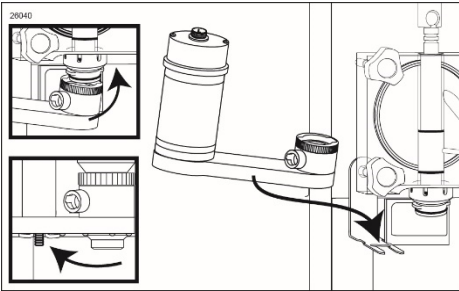

10. Push up on the Blending Assembly and lift the locking collar up and over the adapter tabs. Rotate the locking collar over the tabs to secure.

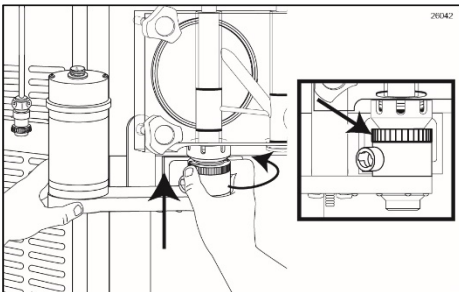

11. Connect the Drive Motor cable to the Motor.

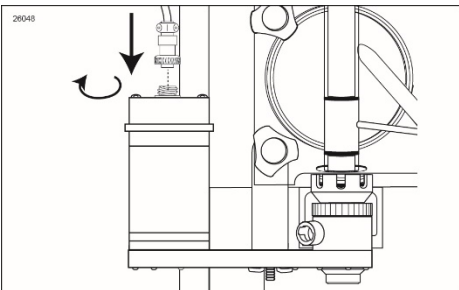

12. Ensure that the Gear Box of the Blending Assembly is level horizontally and the Drive Motor is straight vertically as it rests on the bracket. Install the thumb nut and tighten to secure the assembly's position.

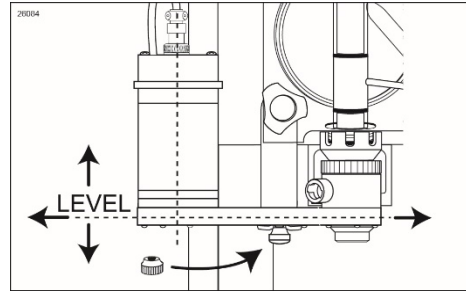

NOTE: THE SUSPENSION BRACKET SHOULD BE POSITIONED ON THE GEAR BOX DURING INITIAL SET-UP AND DOES NOT NEED TO BE REMOVED DURING OPENING OR CLOSING PROCEDURES UNLESS IT REQUIRES A MORE THOROUGH CLEANING. THE SUSPENSION BRACKET SHOULD BE CLEANED AT LEAST EVERY 30 DAYS, EITHER WHEN CLEAN-IN-PLACE PROCEDURE IS PERFORMED AND/OR WHEN THE FREEZER DOOR IS REMOVED FOR CLEANING.

13. Insert the syrup line manifold end fully into the Blending Head syrup line opening. Rotate it until motion stops to secure.

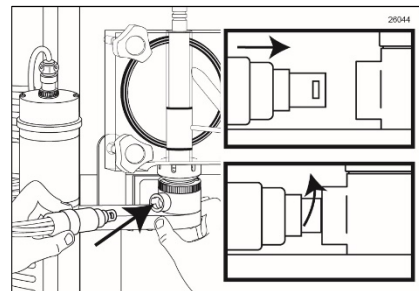

Mounting the Tube / Cable Casing Assemblies

The STL-40BLD-JR includes two tube / cable casing assemblies. The magnetic metal casing assembly is designed to cover and hold the 9-Tube Assembly level with the Blending Assembly. It also channels the tubes, the Drive Motor cable, and the Touch Panel ethernet cable back to the rear of the freezer. The smaller, black plastic casing is for channeling the Touch Panel ethernet cable and draw switch cable down the side of the freezer, to the metal casing.

The following instructions and illustrations show a left-side mounting, but right-side mounting is possible when the Blending Assembly is installed on the right.

1. Prepare detergent water by mixing several drops of Dawn® dish soap with a gallon of warm water (108°F / 42°C).
2. Determine where the metal casing assembly will be placed. The curved ends of the casing typically hang over the front and back of the freezer, and is level horizontally with the 9-Tube Assembly, the syrup line manifold, and the Blending Head syrup port. This puts the least amount of strain on where the manifold connects with the Blending Head.

In some cases, the Drive Motor extends past the side of the freezer and will not allow for the front end of the casing to be placed forward. In these instances, the casing will need to be installed further back, and above the level of the 9-tube assembly, to allow the tubes to curve slightly downward and around the Motor.

Above all, ensure the syrup line manifold is level horizontally with the Blending Head syrup port and the tubes are not putting strain on the connection upward or downward.

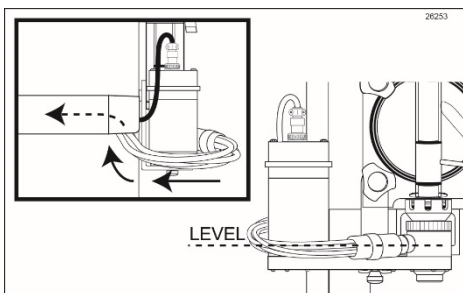

3. The casing assembly contains very power magnets to attach to the side of the freezer. Simply place the assembly in line with the Blending Assembly with the hinged surface downward (screws at the top). The casing assembly should be level horizontally.

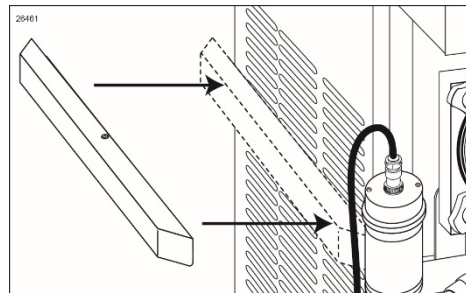

4. Remove the screw from the top of the casing assembly.

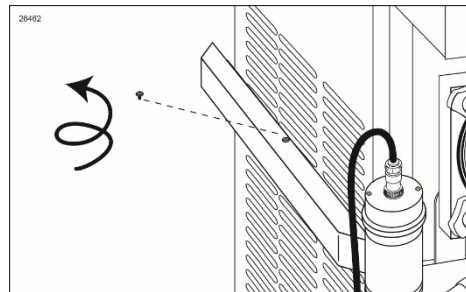

5. Swing the casing cover open.

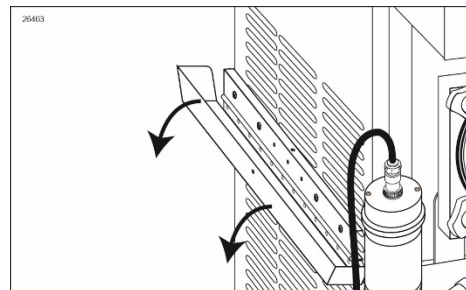

6. Place the 9-Tube Assembly tubes inside the casing. Also place the Drive Motor cable inside this casing. Pull any excess tubes and cables to the back of the freezer, allowing enough slack in the front to comfortably curve around to the Blending Assembly, but not enough to droop or hang.

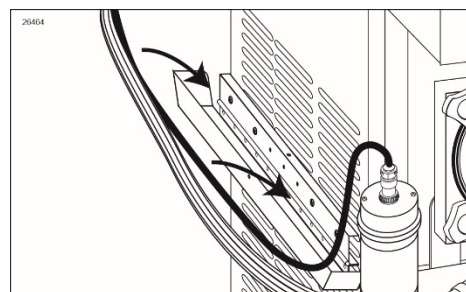

7. Determine where the plastic casing will be installed. Typically, it is installed along the side of the freezer, at the front corner, and just above the metal casing assembly. Clean this area with detergent water, rinse with warm water (108°F / 42°C), and dry with a single service towel.

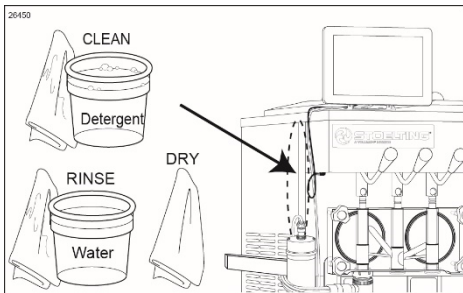

8. Hold the plastic casing in position, about 2" above the metal casing, with the opening seam towards the front. Mark on the casing where the freezer side panel meets the cap of the freezer. Also, mark where it meets the bottom edge of the freezer overhang.

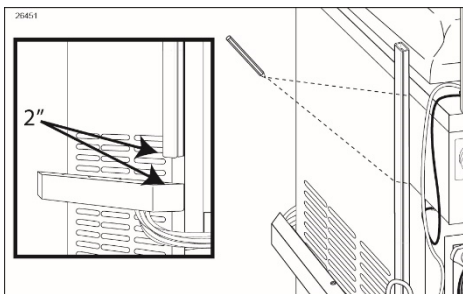

9. Trim the casing at the upper mark. Then, open the casing and clip a small ($\frac{1}{4}$ " – $\frac{1}{2}$ ") hole along the open edge where the second mark was made. This will be an exit hole for the draw switch extension cable.

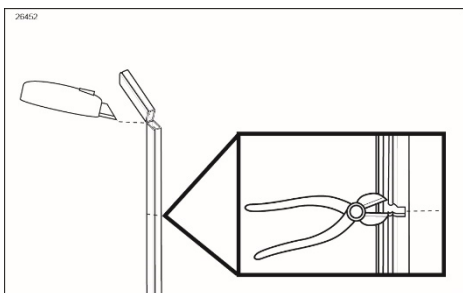

10. Remove the protective tape from the plastic cable casing, and apply the casing to the cleaned area, with the small hole level with the bottom of the overhang.

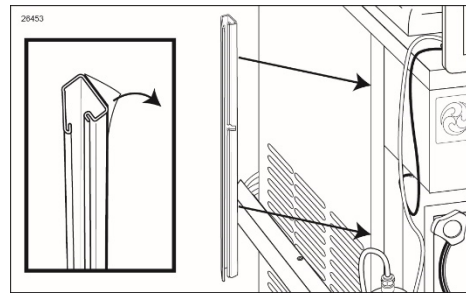

11. Feed the Touch Panel's ethernet cable and switch extension cable inside the casing. Have the switch cable exit through the small hole, with as little slack to the jack port as possible.

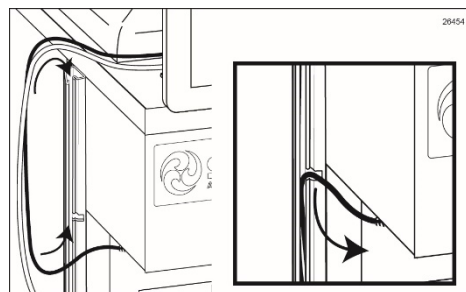

12. Close the casing and press along the seam until it snaps closed.

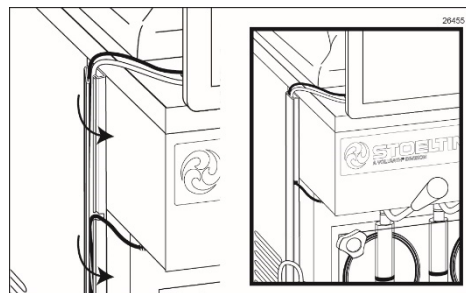

13. Place the ethernet cable inside the metal casing. Close the casing, taking care not to pinch any of the cables and tubes. Install the screw to secure the casing.

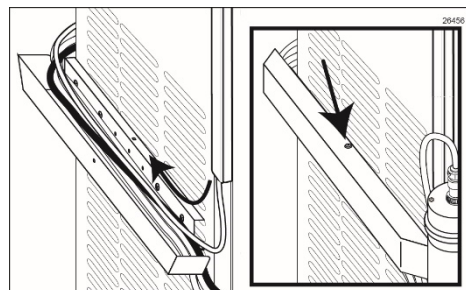

Connecting the Unit Syrup Line

The syrup lines attached at the lower back of the cabinet connect the four bags of syrup to the Blending Assembly, with the fifth tube connecting the sanitizer tank to the Blending Assembly.

1. Locate the 5-Tube Lead at the back of the cabinet. Remove the dust cap and slide the coupler casing toward the unit to expose the lead line coupler.

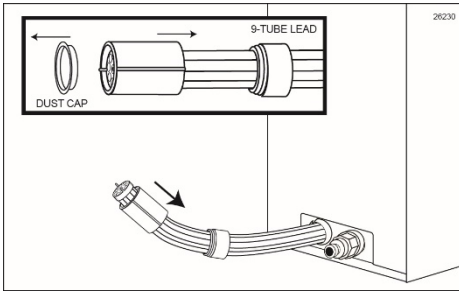

2. Remove the 9-hole gasket from the end of the 9-Tube Assembly line. Spray the end of the 9-Tube Assembly, the gasket, and the end of the lead with sanitizer solution. Allow these parts to sanitize for at least 5 minutes.

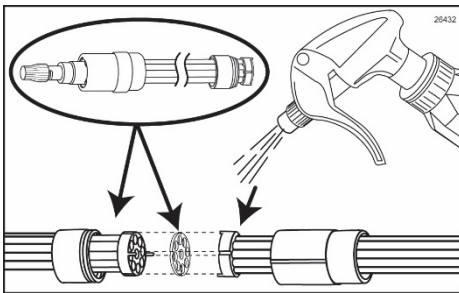

3. Align the 9-hole gasket with the coupler pins of the 5-Tube Lead and place the gasket against the coupler. Then align the coupler pins of the two tube assemblies and connect them.

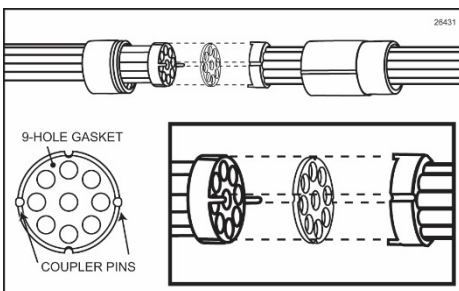

4. Slide the coupler casing over the connection and screw each coupler nut into each end of the casing. Tighten the coupler nuts to secure the connection.

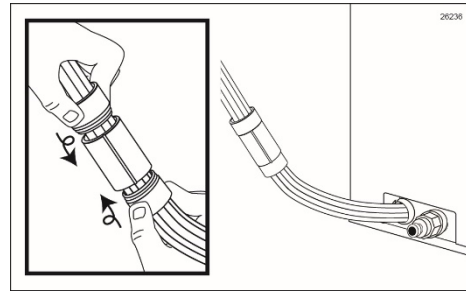

Installing & Filling the Sanitizer Tank

For day-to-day operations, use Flo-San® sanitizer mixed according to the manufacturer's instructions in the sanitizer tank. The tank system delivers solution to specific areas of the Flavor Burst® system such as the Blending Head and syrup lines during certain functions. Therefore, check the tank levels on a daily basis. For proper sanitation, use only FRESH sanitizer solution in the tank that is no more than 28 days old. Replace older solution with fresh sanitizer solution.

1. Insert one end of the sanitizer tube into the fitting located at the lower back of the cabinet.

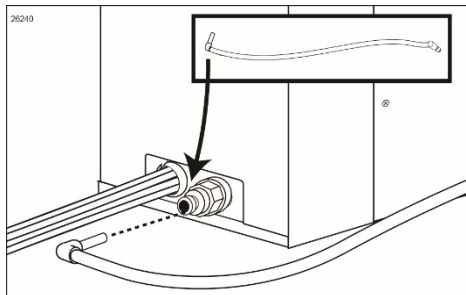

- Mix one packet (0.50 oz) of Flo-San® with two gallons of warm water (108°F / 42°C) until dissolved. Pour the sanitizer solution into the tank.

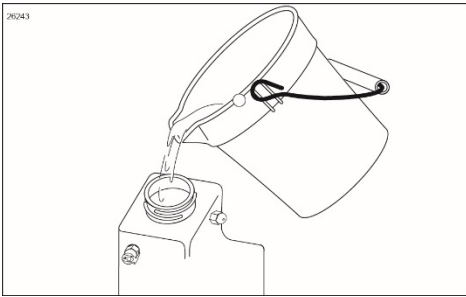

- Reinstall the cap and tighten sufficiently.

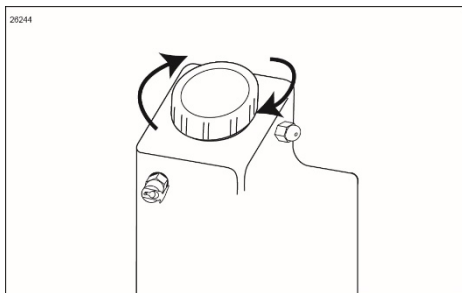

- Set the sanitizer tank on a surface level with the bottom of the cabinet and within distance of the sanitizer tube.

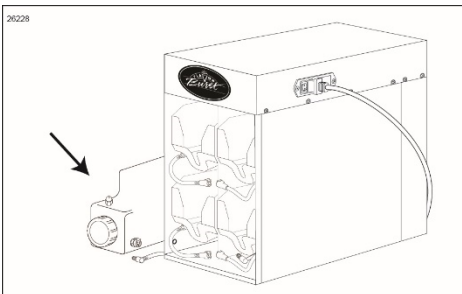

- Connect the other end of the sanitizer tube into the fitment on the sanitizer tank.

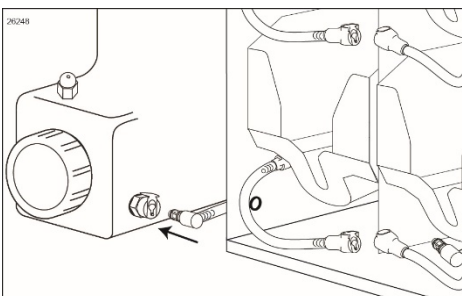

Power Connections and Power Up

The Color Touch Panel's ethernet cable and the Drive Motor cable connections are located on the back of the Junior cabinet. The power supply with the On-Off switch and the power cable are located on the side of the cabinet cap. This is so that the cabinet can be turned off and on more easily if the cabinet is inside a cart or other cabinet.

NOTE: ELELCTRICAL HAZARD - DO NOT HANDLE OR OPERATE NEAR WATER.

- Find the power entrance module on the side of the cabinet. Ensure the power-switch is in the "off" position with the "O" end pressed in.

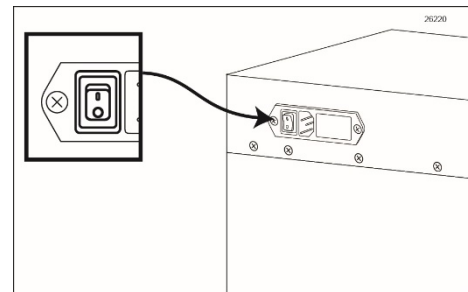

- At the back of the cabinet, connect the Drive Motor cable to the round metal port.

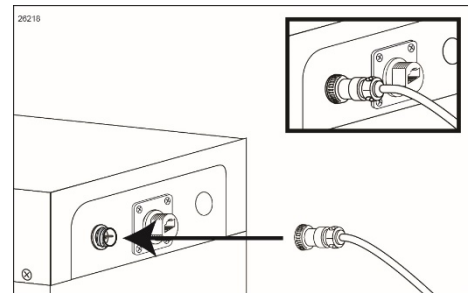

- Connect the ethernet cable to the ethernet port in the plastic gland. Screw the plastic cover over the connection and secure the ethernet gland assembly with the nut.

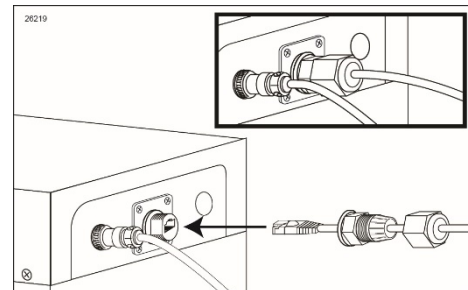

- Connect the power cord to the power entrance module.

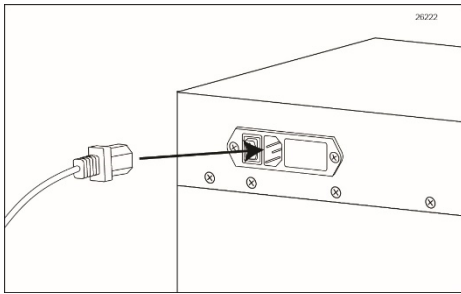

- Plug the power cord into an outlet.
- Activate the unit by pressing the “I” end of the switch.

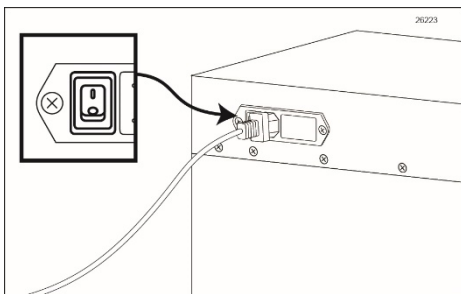

- Turn on the Touch Panel by pressing the small round black power button on the back casing of the Touch Panel. There is also a smaller power button between the casing and the screen.

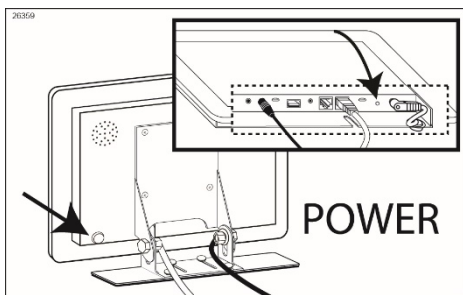

- Most likely, settings on the Touch Panel will need to be adjusted according to the operator’s preference. Serving modes, flavor timing, serving sizes, changing the menu flavor names and more features are outlined in the COLOR TOUCH PANEL OPERATIONS MANUAL. For the initial set-up, however, proceed with the rest of this section before making those adjustments.

Installing Flavors and Priming Syrup Lines

Each flavor for the STL-40BLD-JR system is stored inside a numbered syrup tray within the system cabinet. Under normal operating conditions flavors are installed as previous flavors are emptied. However, you may change flavors periodically as desired.

- Prepare detergent water by mixing several drops of Dawn® dish soap with a gallon of warm water (108°F / 42°C).
- Remove each tray from the cabinet and clean them with detergent water. Rinse with warm water (108°F / 42°C) and dry thoroughly.

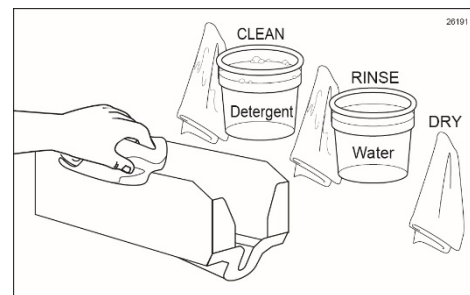

- Select the syrup flavor you wish to use, then place the bag on the table with the fitment up and remove the dust cap.

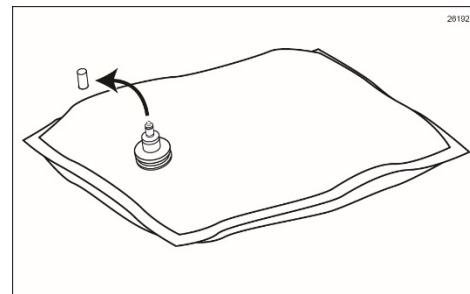

- Lifting up with the bag fitment, press the center pin of the bag fitment valve and gently press on the bag to release any excess air.

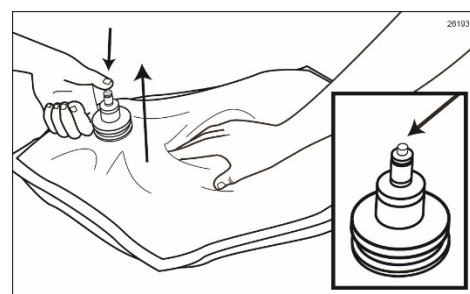

5. Select a numbered tray to correspond with the flavor you have chosen.
6. Grip the bag underneath the fitment and lift the bag up, with your other hand supporting the bottom of the bag. Flip the fitment end over into the open end of the tray, while guiding the back end of the syrup bag into the back end of the syrup tray.

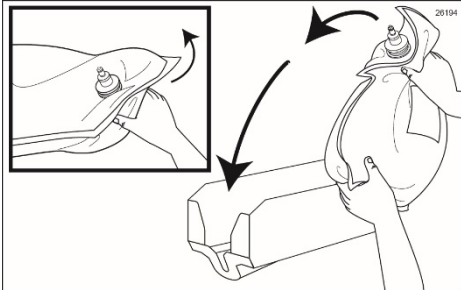

7. Settle the bag into the tray evenly, with the fitment behind the tray opening.

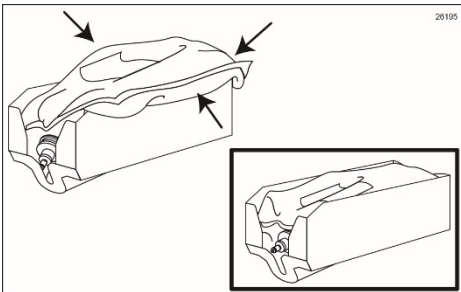

8. Make sure the syrup bag is settled neatly into the tray, and then install the loaded tray into the cabinet.

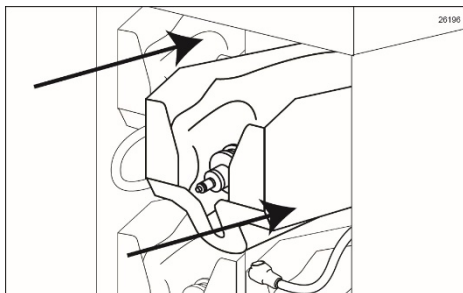

9. At this time, you may wish to change the Touch Panel menu flavor names to coordinate with the new flavors installed. This may be done now or later in the TOUCH PANEL OPERATIONS MANUAL.
10. Perform the entire Clean-In-Place procedure as instructed in the SCHEDULED MAINTENANCE section. The Clean-In-Place procedure **MUST** be done during the initial setup of the STL-40BLD-JR to ensure all the parts and syrup lines are sanitized and ready for use.
11. After the Clean-In-Place procedure, the syrup lines will be filled with sanitizer solution. To prime the syrup lines with the new syrup flavors, follow the full instructions outlined in the SCHEDULED MAINTENANCE – PRIMING THE SYRUP SYSTEM in the previous section of this manual.

COLOR TOUCH PANEL OVERVIEW

Nearly all instructions involving the Touch Panel, setup and operational, are outlined on the Touch Panel itself. This section of the manual gives only basic steps on how to access these instructions. Use the Touch Panel for complete setup and operational instructions. Detailed instructions and screenshots of the Touch Panel can also be found in the COLOR TOUCH PANEL OPERATIONS MANUAL.

The STL-40BLD-JR Touch Panel is the control center for most of the system's operations. With this Touch Panel, the operator can easily select the desired flavors to dispense for each serving, activate and set serving sizes, set and change flavors featured on the Touch Panel menu, adjust flavor concentration per flavor, adjust the flavor dispense timing for multi-flavored servings, access the current serving count and more. The operator can even protect these settings with a pass code. Touch Panel keys are easy to read and are activated with a light touch of the finger. Additional programming features are also available to change or add new flavor labels and the Touch Panel can even be programmed for different languages.

The STL-40BLD-JR system is simple to use with the Touch Panel selection of flavors. More than one flavor can be selected for each serving. Simply select the Touch Panel flavors desired in the single serving and draw the product as usual. The flavors will dispense in one smooth motion, changing in the order selected, resulting in the mixing of flavors. The number of different flavors that can be dispensed per serving depends on the size of the serving, the dispense rate of the flavors, and the product flow setting of the freezer. The STL-40BLD-JR system will also dispense plain product if no flavors are selected on the Touch Panel.

NOTE: IN OUR CONTINUAL EFFORT TO IMPROVE OUR PRODUCTS, PROGRAM UPGRADES MAY BE AVAILABLE FOR THE TOUCH PANEL. PLEASE VISIT WWW.FLAVORBURST.COM FOR THE LATEST DEVELOPMENTS AND INSTRUCTIONS.

Quick Reference Guide for Color Touch Panel Setup

The STL-40BLD-JR Touch Panel has a maintenance menu section where all of your settings are located. Access and customize these settings for your own personal operations and make adjustments as needed.

1. Press and hold any area on the upper Touch Panel until the Maintenance Menu appears.
 2. If the screen asks for a password, enter the password. If a password is forgotten, a procedure has been established to obtain a password override. Please contact Flavor Burst Company for more details.
 3. The Flavor Burst Maintenance Menu is your command center for adjusting all your settings. Begin with the "Initial Touch Panel Setup" and work your way through each section through the "Equipment Setup". These sections help you set up your equipment, syrup names, dispense timings, and many other features.
 4. Under the section "Maintenance Functions", you can adjust how long it takes the unit to flush or prime before it automatically shuts off. You can also add or remove the FLUSH SPOUT button from the main screen.
 5. Then, visit sections under "Serving Options" to make additional setting preferences.
 6. Once all your settings are adjusted, press BACK to exit the Maintenance Menu and return to the main screen.
- NOTE:** FOR MORE THOROUGH DETAILS AND IMAGES OF THE TOUCH PANEL SETUP AND FEATURES, PLEASE REFER TO YOUR TOUCH PANEL OPERATIONS MANUAL.
7. Test your setup in the following section "Testing the STL-40BLD-JR System".

Testing the STL-40BLD-JR System

Once the system is enabled to dispense flavors, test each flavor to ensure they all dispense properly and that the Blending Assembly operates correctly. Draw several servings choosing all the different options available for your setup to verify the Color Touch Panel settings are acceptable.

NOTE: EQUIPMENT AND PRODUCT IMAGES MAY DIFFER FROM YOUR SETUP. HOWEVER, THE INFORMATION AND INSTRUCTIONS STILL APPLY.

1. Make your serving selections on the screen.



NOTE: DEPENDING ON YOUR SETUP, YOU MAY FIRST BE ASKED TO MAKE ADDITIONAL SELECTIONS FOR SERVING CONTAINER TYPE AND SERVING SIZE BEFORE MAKING FLAVOR SELECTIONS.

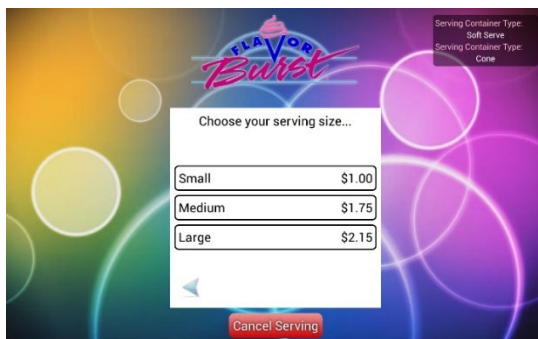
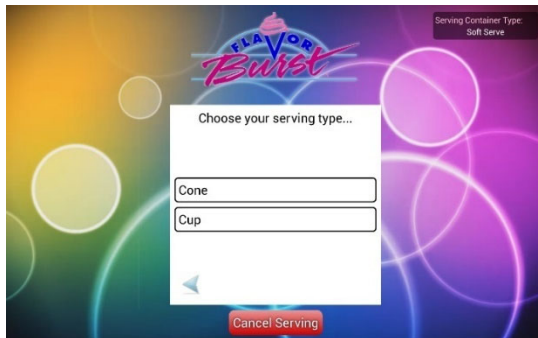

2. **MANUAL DRAW:** Hold a container under the spout to catch flavor product. Pull the draw handle down to dispense product. If you have the timed servings enabled, draw the serving until the system sounds a beep and the screen notifies you to stop drawing product. Return the handle to the closed position at the end of the serving.

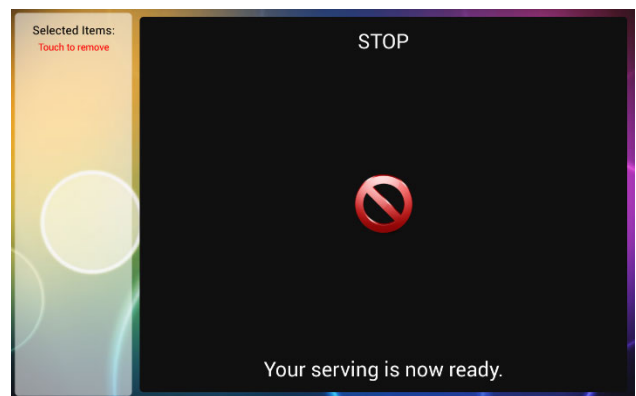
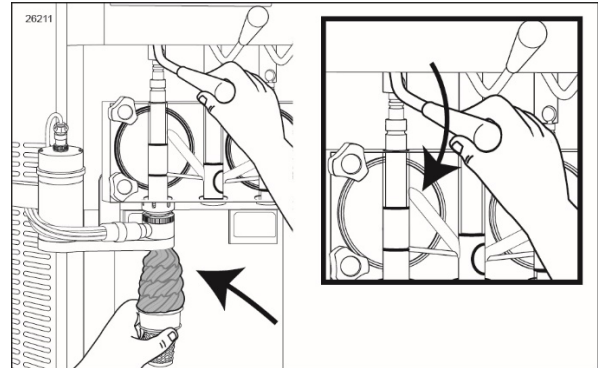

NOTE: IF YOUR SYSTEM HAS A DRAW HANDLE SWITCH, PRESS THE SWITCH AGAINST THE DRAW HANDLE WHILE MOVING THE DRAW HANDLE INTO THE FULL "OPEN" POSITION. THIS ACTIVATES THE FLOW OF SYRUP TO THE SPOUT.

NOTE: IF THE FREEZER IS EQUIPPED WITH A DRAW HANDLE SWITCH, RELEASE THE SWITCH ONE SECOND BEFORE CLOSING THE SERVING. THIS WILL STOP THE FLOW OF SYRUP WHILE GIVING THE UNFLAVORED PRODUCT ENOUGH TIME TO CLEAR THE BLENDING HEAD OF EXTRA FLAVORING AND REDUCE CARRYOVER.

NOTE: THE SYSTEM DISPENSES THE FLAVORS IN THE ORDER THEY WERE SELECTED. ALLOW ENOUGH TIME FOR EACH OF THE FLAVORS TO CYCLE THROUGH. IF THE SERVING IS CUT OFF TOO SOON THE SYSTEM MAY NOT DISPENSE ALL THE CHOSEN FLAVORS IN YOUR SERVING.

- Evaluate your serving for both appearance and taste. Look and taste the serving to ensure the syrup level is acceptable. Draw servings of the other flavors to evaluate their syrup dispensing levels.

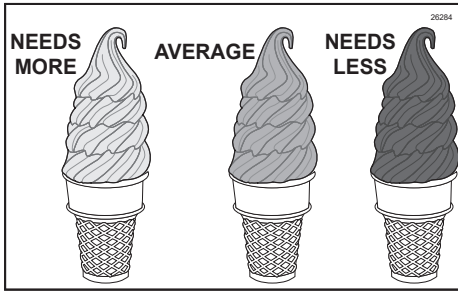

NOTE: ADJUST THE DISPENSE SPEEDS OF THE FLAVORS IN THE “SETUP TRAYS AND DISPENSE SPEEDS” SECTION OF THE MAINTENANCE MENU.

NOTE: YOU CAN ALSO ADJUST THE FLAVOR STRENGTH IN A SERVING BY SLOWING OR SPEEDING UP THE FREEZER’S DRAW RATE.

- If the timed servings setting is enabled, draw different serving sizes and compare them to see if the size of each serving is what you expected.

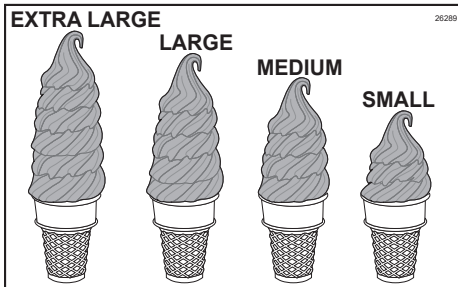

NOTE: CHANGE THE SERVING SIZE TIMES IN THE “ADJUST DISPENSE TIME LIMITS” SECTION OF THE MAINTENANCE MENU.

- If the white cap option is enabled, see if syrup product has cleared the Blending Head. Make sure there is not too much unflavored product at the top of your serving.

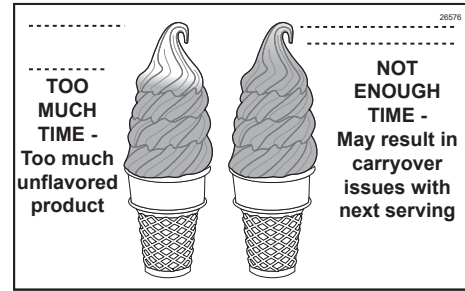

NOTE: ADJUST THE WHITE CAP TIME IN THE “ENABLE OR DISABLE SERVING OPTIONS” SECTION OF THE MAINTENANCE MENU.

NOTE: THE WHITE CAP OPTION IS ONLY AVAILABLE WHEN TIMED SERVING SIZES IS ACTIVATED.

- Draw multi-flavored servings to evaluate if the layer timing is what you expected. A shorter dispense time results in narrower layers; a longer dispense time results in wider layers. You can fit more flavor selections in a serving with narrow layers, however, the layers may blend together. Wider layers will show a more distinct color and flavor difference between layers, but will have limitations on how many flavors can be dispensed in one serving.

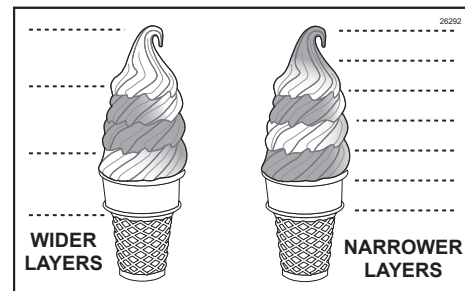

NOTE: ADJUST THE FLAVOR SELECTION TIME IN THE “ENABLE OR DISABLE SERVING OPTIONS” SECTION OF THE MAINTENANCE MENU.

7. Make any other adjustments to settings in the Maintenance Menu settings as needed.
8. If a syrup line fails to operate when tested, select that flavor on the Touch Panel and draw the serving again to verify the syrup pump is malfunctioning. Contact White Glove Service for help.
9. On occasion, it may be desirable to sanitize the Blending Head between servings. Simply hold a container under the dispensing spout and press FLUSH SPOUT.

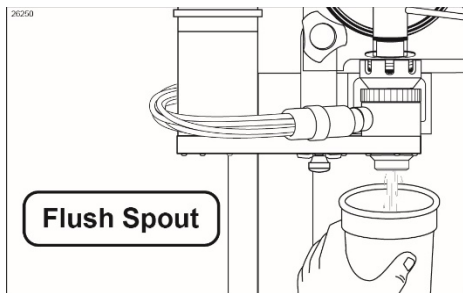

10. **NOTE:** IF NO "FLUSH SPOUT" BUTTON IS SHOWN ON THE SCREEN, YOU CAN FLUSH THE SPOUT BY ACCESSING THE MAINTENANCE MENU AND SELECTING THE "FLUSHING FUNCTIONS" SECTION.

DIRECTORY OF CLEANING PROCEDURES

The various cleaning and sanitizing procedures for the STL-40BLD-JR are arranged in this manual according to when and how often the procedures need to be done. Use the following directory as a quick reference to all the cleaning procedures within this operations manual.

DAILY OPENING PROCEDURES - page 22

- Blending Head
- Gear Cartridge
- Gear Box
- Spout Adapter and O-rings
- 9-Tube Assembly Opening

DAILY CLOSING PROCEDURES - page 26

- Blending Head
- Gear Cartridge
- Gear Box
- Spout Adapter and O-rings
- 9-Tube Assembly opening
- Drive Motor
- Touch Panel
- Exposed Surfaces of the Cabinet

SCHEDULED MAINTENANCE (every 30 days) - page 34

- 9-Tube Assembly Parts
- Syrup Lines - Internal
- Syrup Bag Connectors
- Syrup Bag Fitments
- Spout Adapter and O-Rings
- Blending Assembly Suspension Bracket
- Area Under the Cabinet
- Inside the Cabinet
- Blending Assembly Suspension Bracket
- Tube / Cable Casing Assemblies
- 9-Tube Assembly Syrup Lines
- Touch Panel and Mounting Assembly

PARTS REPLACEMENT SCHEDULE

The following schedule has been prepared as a reference for maintaining the wear items used with the STL-40BLD-JR system. Many factors affect the useful life of wear items including climate, store hours, store traffic, sales volumes, etc. Therefore, each operator must determine an appropriate schedule for his or her unique operation. Wear items should be checked frequently during opening and closing procedures and replaced as needed.

The Spare Parts Kit should contain replacements for these wear items. Be sure to keep replacements in stock inside the Spare Parts Kit for easy access.

Part No.	Part Description	Every 3 months	Every 6 months	Annually
FLAVOR BURST® COMPONENTS				
STOEDPT500FBA	Standard Spout Adapter with O-Rings		Inspect and replace if necessary	Minimum
STOERUB653	Upper O-Ring for STOEDPT500FBA Spout Adapter	X		
STOERUB632	Lower O-Ring for Spout Adapter	X		
STOEINJ321C	Gear Cartridge (inspect daily)		Minimum	
STOERUB601	Duckbill Check Valve		X	
STOERUB651	Blending Head O-ring 2-020	X		
STOERUB660	Larger Syrup Port O-ring	X		
STOERUB652-RSS	Small Blending Head O-ring	X		

RECOMMENDED MAINTENANCE ITEMS REPLACEMENT SCHEDULE

The following maintenance tools are recommended utensils for the STL-40BLD-JR system cleaning procedures. These items are not included with the system but are available for purchase through www.PartsTown.com. Suitable alternatives for these maintenance items may be available. Contact [White Glove Service](#) for more information. The following schedule has been prepared as a reference for maintaining the cleaning tools.

Part No.	Part Description	Every 3 months	Every 6 months	Annually
2209839	Maintenance Brush Kit <i>(includes items listed below)</i>		Inspect & replace if necessary	Minimum
208409*	Bristle Brush (1 ½" dia. x 4")		Inspect & replace if necessary	Minimum
208465*	Bristle Brush (1" dia.)		Inspect & replace if necessary	Minimum
208387*	Bristle Brush (1/2" dia. x 5")		Inspect & replace if necessary	Minimum
208001*	Detail Brush (1/16" dia.)		Inspect & replace if necessary	Minimum

THE BRUSHES WITH THE ASTERISK () INDICATE THE TOOL IS A PART OF THE MAINTENANCE BRUSH KIT (PART #2209839)

ALTERNATE PARTS AND KITS BY FREEZER MODEL

Stoelting offers many equipment options and accessories through [White Glove Service](#) that may be helpful for your operational or installation requirements. This includes adapter kits, adapters, brackets, and switches for various freezer models. Please contact [White Glove Service](#) at 800-319-9549 or visit www.PartsTown.com and www.flavorburst.com for additional information concerning other optional accessories, advertising and promotional materials.

Service Requests and Ordering:

For all your service needs, call Stoelting Company's

White Glove Service Network:

Phone: 1-800-319-9549

Distributed by:

Stoelting Foodservice Equipment

502 Highway 67

Kiel, WI 53042-1600

U.S.A

www.stoeltingfoodservice.com

Manufactured by:

Flavor Burst Company

499 Commerce Drive

Danville, IN 46122

U.S.A.

www.flavorburst.com

Data Plate

The data plate provides necessary information that the operator should record and refer to when calling for parts or service. The data plate is located on the center panel inside the cabinet.

Complete for quick reference when this information is requested.

1. Model Number: STL-40BLD-JR_____
2. Serial Number _____
3. Voltage _____
4. Maximum Fuse Size _____ Amps
5. Minimum Wire Ampacity _____ Amps

Flavor Burst is a registered trademark of the Flavor Burst Company. Stoelting is a registered trademark of the Stoelting Company. All rights reserved.

